

DEXIBELL

VIVO | S9 |

stage piano

Owner's Manual



Regulatory and Safety Information

Users in U.S.A

This product has been tested and found to comply with the limits for a Class B digital devices, pursuant to Part 15 of the FCC Rules. These limits are designed to provide reasonable protection against harmful interference in a residential installation. This equipment generates, uses, and can radiate radio frequency energy and, if not installed and used in accordance with the instructions, may cause harmful interference to radio communications. However, there is no guarantee that interference will not occur in a particular installation. If this equipment does cause harmful interference to radio or television reception, which can be determined by turning the equipment off and on, the user is encouraged to try to correct the interference by one or more of the following measures:

- Reorient or relocate the receiving antenna.
- Increase the separation between the equipment and receiver.
- Connect the equipment into an outlet on a circuit different from that to which the receiver is connected.
- Consult the dealer or an experienced radio/TV technician for help.

This device complies with part 15 of the FCC Rules. Operation is subject to the following two conditions:

- 1) This device may not cause harmful interference.
- 2) This device must accept any interference received, including interference that may cause undesired operation.

FCC CAUTION: Any unauthorized changes or modifications not expressly approved by the party responsible for compliance could void the user's authority to operate the equipment.

Note: The manufacturer is not responsible for any radio or tv interference caused by unauthorized modifications to this equipment. Such modifications could void the user's authority to operate the equipment.

Radiation Exposure Statement

The available scientific evidence does not show that any health problems are associated with using low power wireless devices. There is no proof, however, that these low power wireless devices are absolutely safe. Low power Wireless devices emit low levels of radio frequency energy (RF) in the microwave range while being used. Whereas high levels of RF can produce health effects (by heating tissue), exposure of low-level RF that does not produce heating effects causes no known adverse health effects. Many studies of low-level RF exposures have not found any biological effects. Some studies have suggested that some biological effects might occur, but such findings have not been confirmed by additional research. This device has been tested and found to comply with FCC radiation exposure limits set forth for an uncontrolled environment and meets the FCC radio frequency (RF) Exposure Guidelines in Supplement C to OET65.

Users in Canada

This device complies with Industry Canada licence-exempt RSS standard(s). Operation is subject to the following two conditions:

- (1) this device may not cause interference, and
- (2) this device must accept any interference, including interference that may cause undesired operation of the device.

Le présent appareil est conforme aux CNR d'Industrie Canada applicables aux appareils radio exempts de licence. L'exploitation est autorisée aux deux conditions suivantes : (1) l'appareil ne doit pas produire de brouillage, et (2) l'utilisateur de l'appareil doit accepter tout brouillage radioélectrique subi, même si le brouillage est susceptible d'en compromettre le fonctionnement.

Under Industry Canada regulations, this radio transmitter may only operate using an antenna of a type and maximum (or lesser) gain approved for the transmitter by Industry Canada. To reduce potential radio interference to other users, the antenna type and its gain should be so chosen that the equivalent isotropically radiated power (e.i.r.p.) is not more than that necessary for successful communication.

Conformément à la réglementation d'Industrie Canada, le présent émetteur radio peut fonctionner avec une antenne d'un type et d'un gain maximal (ou inférieur) approuvé pour l'émetteur par Industrie Canada. Dans le but de réduire les risques de brouillage radioélectrique à l'intention des autres utilisateurs, il faut choisir le type d'antenne et son gain de sorte que la puissance isotrope rayonnée équivalente (p.i.r.e.) ne dépasse pas l'intensité nécessaire à l'établissement d'une communication satisfaisante.

Radiation Exposure Statement

The available scientific evidence does not show that any health problems are associated with using low power wireless devices. There is no proof, however, that these low power wireless devices are absolutely safe. Low power Wireless devices emit low levels of radio frequency energy (RF) in the microwave range while being used. Whereas high levels of RF can produce health effects (by heating tissue), exposure of low-level RF that does not produce heating effects causes no known adverse health effects. Many studies of low-level RF exposures have not found any biological effects. Some studies have suggested that some biological effects might occur, but such findings have not been confirmed by additional research. This device has been tested and found to comply with IC radiation exposure limits set forth for an uncontrolled environment and meets RSS-102 of the IC radio frequency (RF) Exposure rules.

Les connaissances scientifiques dont nous disposons n'ont mis en évidence aucun problème de santé associé à l'usage des appareils sans fil à faible puissance. Nous ne sommes cependant pas en mesure de prouver que ces appareils sans fil à faible puissance sont entièrement sans danger. Les appareils sans fil à faible puissance émettent une énergie radioélectrique (RF) très faible dans le spectre des micro-ondes lorsqu'ils sont utilisés. Alors qu'une dose élevée de RF peut avoir des effets sur la santé (en chauffant les tissus), l'exposition à de faibles RF qui ne produisent pas de chaleur n'a pas de mauvais effets connus sur la santé. De nombreuses études ont été menées sur les expositions aux RF faibles et n'ont découvert aucun effet biologique. Certaines études ont suggéré qu'il pouvait y avoir certains effets biologiques, mais ces résultats n'ont pas été confirmés par des recherches supplémentaires. Cet appareil a été testé et jugé conforme aux limites d'exposition aux rayonnements énoncées pour un environnement non contrôlé et respecte les règles d'exposition aux fréquences radioélectriques (FR) RSS-102 de l'IC.

VIVO | S9 |

s t a g e p i a n o

Owner's Manual

Welcome to the reference manual of the S9 and congratulations for purchasing this instrument.

The S9 stage piano is the top-class digital stage piano of the VIVO series. The realistic 88 keys hammer action keyboard (enhanced with real wood parts) and the T2L sampling & Modelling technology (24 bit / 48 KHz) contributes to simulate the realistic responsiveness of a real acoustic piano through virtually unlimited polyphony. A dedicated sections with powerful real-time controls give you maximum expression on stage. The organ section with nine motorised draw-faders and many effects as rotary, percussion, vibrato, chorus, allows you to enjoy full-fledged organ sounds in your performances. Furthermore, the sound section allows you to select the best selection of Pianos, Brass, Synths sounds with undeniable Dexibell sound quality.

All this and more makes the S9 the ideal all-in one solution for performing keyboard players.

To ensure that you obtain the maximum enjoyment and take full advantage of the organ functionality, please read all sections of this owner's manual carefully.

Keep this manual handy for future reference.



Start to take advantage of valuable benefits available simply registering your product on www.dexibell.com.

- You can benefit of DEXIBELL's **3 years** extended warranty (*The extended warranty is subject to terms and conditions. Please refer to the related section*).
- Keeps you updated on special offers.
- You can be updated on any new software release and new sounds.

For European countries



| | | | |
|--|--|--|--|
| | <p>This Symbol indicates that in EU countries, this product must be collected separately from household waste, as defined in each region. Products bearing this Symbol must not be discarded together with household waste.</p> | | <p>Tento symbol vyjadruje, že v krajinách EÚ sa musí zber tohto produktu vykonávať oddelene od domového odpadu, podľa nariadení platných v konkrétnej krajine. Produkty s týmto symbolom sa nesmú vyhazovať spolu s domovým odpadom.</p> |
| | <p>Questo simbolo indica che nei paesi della Comunità europea questo prodotto deve essere smaltito separatamente dai normali rifiuti domestici, secondo la legislazione in vigore in ciascun paese. I prodotti che riportano questo simbolo non devono essere smaltiti insieme ai rifiuti domestici. Ai sensi dell'art. 13 del D.Lgs. 25 luglio 2005 n. 151.</p> | | <p>Ez a szimbólum azt jelenti, hogy az Európai Unióban ezt a terméket a háztartási hulladéktól elkülönítve, az adott régióban érvényes szabályozás szerint kell gyűjteni. Az ezzel a szimbólummal ellátott termékeket nem szabad a háztartási hulladék közé dobni.</p> |
| | <p>Ce symbole indique que dans les pays de l'Union européenne, ce produit doit être collecté séparément des ordures ménagères selon les directives en vigueur dans chacun de ces pays. Les produits portant ce symbole ne doivent pas être mis au rebut avec les ordures ménagères.</p> | | <p>Tämä merkintä ilmaisee, että tuote on EU-maissa kerättävä erillään kotitalousjätteistä kunkin alueen voimassa olevien määräysten mukaisesti. Tällä merkinnällä varustettuja tuotteita ei saa hävittää kotitalousjätteiden mukana.</p> |
| | <p>Dieses Symbol bedeutet, dass dieses Produkt in EU-Ländern getrennt vom Hausmüll gesammelt werden muss gemäß den regionalen Bestimmungen. Mit diesem Symbol gekennzeichnete Produkte dürfen nicht zusammen mit den Hausmüll entsorgt werden.</p> | | <p>Το σύμβολο αυτό υποδηλώνει ότι στις χώρες της Ε.Ε. το συγκεκριμένο προϊόν πρέπει να συλλέγεται χωριστά από τα υπόλοιπα οικιακά απορρίμματα, σύμφωνα με όσα προβλέπονται σε κάθε περιοχή. Τα προϊόντα που φέρουν το συγκεκριμένο σύμβολο δεν πρέπει να απορρίπτονται μαζί με τα οικιακά απορρίμματα.</p> |
| | <p>Este símbolo indica que en los países de la Unión Europea este producto debe recogerse aparte de los residuos domésticos, tal como está regulado en cada zona. Los productos con este símbolo no se deben depositar con los residuos domésticos.</p> | | <p>See sümbol näitab, et EL-i maades tuleb see toode olemprügist eraldi koguda, nii nagu on igas piirkonnas määratletud. Selle sümboliga märgitud tooteid ei tohi ära visata koos olmeprügiga.</p> |
| | <p>Dit symbool geeft aan dat in landen van de EU dit product gescheiden van huishoudelijk afval moet worden aangeboden, zoals bepaald per gemeente of regio. Producten die van dit symbool zijn voorzien, mogen niet samen met huishoudelijk afval worden verwijderd.</p> | | <p>Ta simbol označuje, daje treba proizvod v državah EU zbirati ločeno od gospodinjjskih odpadkov, tako kot je določeno v vsaki regiji. Proizvoda s tem znakom ni dovoljeno odlagati skupaj z gospodinjjskimi odpadki.</p> |
| | <p>Este símbolo indica que nos países da UE, a recolha deste produto deverá ser feita separadamente do lixo doméstico, de acordo com os regulamentos de cada região. Os produtos que apresentem este símbolo não deverão ser eliminados juntamente com o lixo doméstico.</p> | | <p>Šis simbols norāda, ka ES valstīs šo produktu jāievāc atsevišķi no mājsaimniecības atkritumiem, kā noteikts katrā reģionā. Profuktus ar šo simbolu nedrīkst izmest kopā ar mājsaimniecības atkritumiem.</p> |
| | <p>Dette symbol angiver, at i EU-lande skal dette produkt opsamlers adskilt fra husholdningsaffald, som defineret i hver enkelt region. Produkter med dette symbol må ikke smides ud sammen med husholdningsaffald.</p> | | <p>Šis simbolis rodo, kad ES šalyse šis produktas turi būti surenkamas atskirai nuo buitinių atliekų, kaip nustatyta kiekviename regione. Šiuo simboliu paženklininti produktai neturi būti išmetami kaitų su buitiniemis atliekomis.</p> |
| | <p>Dette symbolet indikerer at produktet må behandles som spesialavfall i EU-land, iht. til retningslinjer for den enkelte regionen, og ikke kastes sammen med vanlig husholdningsavfall. Produkter som er merket med dette symbolet, må ikke kastes sammen med vanlig husholdningsavfall.</p> | | <p>Symbolen anger att i EU-länder måste den här produkten kasseras separat från hushållsavfall, i enlighet med varje regions bestämmelser. Produkter med den här symbolen får inte kasseras tillsammans med hushållsavfall.</p> |
| | <p>Symbol oznacza, że zgodnie z regulacjami w odpowiednim regionie, w krajach UE produktu nie należy wyrzucać z odpadami domowymi. Produktów opatrzonych tym symbolem nie można utylizować razem z odpadami domowymi.</p> | | <p>Tento symbol udává, že v zemích EU musí být tento výrobek sbírán odděleně od domácího odpadu, jak je určeno pro každý region. Výrobky nesoucí tento symbol se nesmí vyhazovat spolu s domácím odpadem.</p> |

1 Important Safety Instructions

PLEASE READ CAREFULLY BEFORE PROCEEDING



WARNING

Always follow the following precaution listed below to avoid user to the risk of serious injury or even death from electrical shock, fire or other hazard .

Only use non-tropical weather

This unit and its AC adaptor can only be safely used in non-tropical weather. The operating temperature range is 5° - 40°C (41° - 104°F).



Do not repair, modify or replace parts by yourself

Do not attempt to repair the unit, modify or replace parts of the product. Please contact all the nearest Dexibell Service Center.



Do not disassemble or modify by yourself

Do not open the unit or its AC adaptor or attempt to disassemble or modify the internal component in any way.



Use only the supplied AC adaptor (DEXIBELL DYS602-240250W).

Use only the AC adaptor included with the unit. Connecting a different AC adaptor can cause serious damage to the internal circuitry and may even pose a shock hazard.



Use only the supplied power cord

Use only the AC power cord supplied with the AC adaptor included in the package.



Do not excessively bend the power cord

Do not excessively twist or bend the power cord otherwise you damage it. Damaged cords may cause fire and shock hazards!



Do not place the unit in an unstable location

Do not place the unit in a unstable position where it might accidentally fall over.



Take care not to allow liquid or foreign objects to enter unit; Do not place containers with liquid on unit

Do not place object filled with liquid (glass of water on this product. Never allow foreign objects (e.g., flammable objects, coins, wires) or liquids (e.g., water or juice) to enter this product. Doing so may cause short circuits, faulty operation, or other malfunctions.



Never place or store the product in the following types of locations

- Exposed to extreme cold or heat (such as in direct sunlight, near a heater, or in a car during the day).
- Subject to steam or smoke.
- Damp (such washroom, baths, on wet floors).
- Subject to salt water exposure.
- Exposed to rain.
- Dusty or sandy.
- Subject to extreme changes of temperature or humidity (The condensation may occur and water may collect on the surface of the instrument. Wooden parts may absorb water and be damaged).
- Subject to high levels of vibration and shakiness.



Do not drop the unit or subject it to strong impact

Do not drop the unit. Protect it from strong impact!



Do not connect the unit to an outlet with an unreasonable number of other devices

Do not connect the unit's power-supply cord to an electrical outlet with an unreasonable number of other devices. This could cause the outlet to overheat and possibly cause a fire.



Adults must provide supervision in places where children are present

When using the unit in locations where children are present, never leave the unit unattended. Keep a special watch over any children so that they don't mishandling of the unit can take place.



Avoid extended use at high volume

This unit, either alone or in combination with an amplifier and headphones or speakers, may be capable of producing sound levels that could cause permanent hearing loss. DO NOT operate for a long period of time at a high volume level, or at a level that is uncomfortable. If you experience any hearing loss or ringing in the ears, you should immediately stop using the unit, and consult an audiologist.



If you notice any abnormality turn off the unit immediately

Turn off the unit and remove the AC adaptor from the outlet when:

- If the AC adaptor, the power-supply cord, or the plug has been damaged.
- If smoke or unusual smells occurs.
- If the product has been exposed to rain.
- If objects have fallen into, or liquid has been spilled into the unit.
- If the unit does not operate or exhibits a marked change in performance.
- If the unit has been dropped, or the enclosure of the product has been damaged.



Contact the nearest qualified Service Center.



CAUTION

Always follow the following precaution listed below to avoid user to the risk of serious injury or even death from electrical shock, fire or other hazard .

Grasp the plug connecting or disconnecting the AC adaptor

When removing the electric plug from the instrument or an outlet, always hold the plug itself and not the cord. Pulling by the cord can damage it.



Do not use wet hands to connect or disconnect AC adaptor

Never handle the AC adaptor or its plugs with wet hands when plugging into, or unplugging from, an electrical outlet.



Keep clean the AC adaptor's plug

At regular intervals, unplug the AC adaptor and using a dry cloth clean the adaptor's plug.

If the unit will be unused for an extended period of time, unplug the AC power cord from the AC outlet.



Keep cables from getting entangled

Try to prevent cords and cables from becoming entangled. Place all cords and cables away from children.



Before cleaning the unit, unplug the AC adaptor from the outlet

To avoid electric shock or damage the unit, before cleaning the unit, turn it off and unplug the AC adaptor from the outlet (p. 20).



If there is a possibility of lightning strike in your area, disconnect the AC adaptor from the outlet

If you know a thunderstorm is predicted in your area, disconnect the AC adaptor from the outlet.



Do not rest your weight on or place heavy objects on the unit.

Avoid to climb on top of, nor place heavy objects on the unit.



Cautions when moving this unit

- The unit should be handled carefully, all the while keeping it level.
- Disconnect the power cord and all connected cables.



Place in a well ventilated location

The unit and the AC adaptor should be located so their location or position does not interfere with their proper ventilation.



Do not use in tropical climates

Use the unit and the AC adaptor only in a moderate climates (not in tropical climates).



Place near the socket outlet

This equipment should be installed near the socket outlet and disconnection of the device should be easily accessible.



2 Relevant Indications

In addition to the items listed under "Important Safety Instructions" on p. 5, please read and observe the following:



Power supply related

- Do not plug this unit into the same electrical outlet used same by an electrical appliance that is controlled by an inverter or a motor (such as a refrigerator, washing machine or air conditioner). Doing so, can result an audible noise.
- The power adapter may become warm after long hours of consecutive use. It can be a normal dissipation of heat through the adapter casing. To reduce the possibility of overheating place the power adapter on the floor in a well-ventilated location.
- Before connecting the unit to other equipment, turn off the power to all equipment. Otherwise, electrical shock or damage to the equipment may occur.
- If the unit is not operative for 120 minutes (2 hours), to prevent unnecessary power consumption, this unit features an "AUTO OFF" function that automatically turns the unit off. If you don't want the unit to turn off automatically, change the "AUTO OFF" setting to "OFF" as described on p. 70.

NOTE

The "AUTO OFF" setting is memorized when you switch off the unit.



Maintenance related

- To clean the unit, put a soft cloth in lukewarm water, squeeze it well, then wipe the entire surface using an equal amount of strength. Rubbing too hard in the same area can damage the finish.
- Dust should be removed using a soft feather or wool-type duster. Care should be taken not to apply pressure to the finish or to drag the dust across the finish, which can create fine scratches in the surface. Fingerprints or similar marks can be cleaned with a dampened soft cloth, followed by a dry cloth. In cases of stubborn greasy dirt, using a small amount of mild detergent (such as mild dishwashing liquid) on the damp cloth may help. Do not use any cleaners or detergents, since they might deteriorate the surface of the cabinet, and produce cracks. Do not use dusting cloths that contain chemicals.
- Do not wipe this unit with benzene, alcohol or solvent of any kind. Doing so may result in discoloration and/or deformation of the unit.



Related to appropriate location

- Do not place the unit near power amplifiers (or other equipment containing large power transformers) to avoid induced hum. In case of hum, to reduce the problem, change the orientation of your unit or place it away from the source of interference.
- Do not use this unit in the vicinity of a TV or radio. This unit may interfere with radio and television reception.
- When using this unit along with application on your iPhone/iPad, we recommend that you set "Airplane Mode" to "ON" on your iPhone/iPad in order to avoid noise caused by communication.
- Noise may be produced if cell phones are operated in the vicinity of this unit. In case of noise you should relocate such wireless devices so they are at a greater distance from this unit, or switch them off.
- Do not expose the unit to extreme cold or heat, to direct sunlight or near devices that radiate heat. Do not leave the unit inside a vehicle during the day. Extreme temperature can damage the unit.
- Take care when move the unit from one location to another with drastic changes in ambient temperature. Condensation can occur in the unit due to drastic change of temperature. Using the device while condensation is present can cause damage. If there is reason to believe that condensation might have occurred, leave the device for several hours until the condensation has completely dried out.
- Do not place, for long periods of time, vinyl, plastic or rubber objects on this unit. Such objects can discolor or otherwise harmfully affect the finish.
- Do not place objects for long period of time on top of the keyboard. This can be the cause of malfunction of the keys of the keyboard.
- Do not apply any stickers, decals or self-adhesive material to this unit. The glue is difficult to remove and solvents are damaging the exterior finish.
- Do not place object filled with liquid (glass of water on this unit. Avoid to use alcohol, perfume, hairspray, nail polish, etc., near the unit. In the event of liquid spill on the unit, swiftly wipe away the surface using a dry, soft cloth.



Related to repairs

- Always back up your data on a USB memories before you send this unit for repair to an authorized center. All data contained in the unit's memory may be lost. Important data should always be backed up, or written down on paper (when possible). Dexibell assumes no liability concerning such loss of data.



Related to external memories

- Insert the USB Memory (commercially available) into the slot with care and at the correct angle.
- Take particular care when handling USB Memory:
 - Always ground yourself to something metal before handling an USB Memory.
 - Do not touch the pins of the USB Memory connector, or allow them to become dirty.
 - Do not subject the USB Memory to temperature extremes (e.g., direct sunlight in an enclosed vehicle)-
 - Do not allow the USB Memory to become wet-
 - Do not drop or subject it to excessive shock or vibration.
- Do not disconnect the USB Memory while writing and reading data (i.e., while the USB Memory indicator blinks).
- Never use USB hub to connect USB Memory to the unit.
- This unit allows you to use commercially available USB Memory. You can purchase such devices at a computer store, a digital camera dealer, etc.
- The audio recording require a USB storage device to support high sustained transfer rates. Not all USB devices will guarantee flawless performance.



Related to copyright and trademarks

- Dexibell do not assume legal liability regarding any infringements of the user through the use of this unit.
- Recording, copying, distribution of copyrighted material (songs, live performance, etc.) belonging to a third party in part or in whole without the permission of the copyright owner is forbidden by law.
- iPad® and iPhone® are registered trademarks of Apple Inc.
- App Storesm is an Apple's Service Mark.
- Bluetooth® is registered trademarks of Bluetooth SIG, Inc.



Other precautions

- The contents of memory could be lost due to malfunction or improper operation. To help prevent the loss of your data, we highly recommend that you periodically save a backup copy of important data you have stored in the unit's memory on another storage device. (e.g., USB memories).
- Unfortunately, an error may occur during the data restore previously stored in the USB memories. Dexibell shall not be liable for loss of profits or any consequential loss, loss of data.
- Do not use excessive force when handling unit's buttons, switches, sliders and controls and when use connectors and jacks. Rough handling can cause damage o malfunctions.
- Always pull by the connector when disconnecting a cable, never pull the cable. Not doing so you will cause shorts, or damage to the cable's internal elements.
- Keep the unit's volume levels down. The instrument should be used at a reasonable volume, to avoid disturbing neighbours, especially at night and in the early morning. Use headphones if you want to play your music loud or late at night.
- When you need to transport the unit, put it in its original packaging with padding in the box. Otherwise, you will need to use equivalent packaging materials. When transporting or moving the unit always use two or more people.
- To prevent possible damage, avoid applying excessive force to the music stand.
- For connecting this unit use cable low impedance cables. The use of cables that contain resistor can cause the sound level to be extremely low, or impossible to hear.

Conventions Used in This Manual

The following symbols are used.

- NOTE** It indicates an important note; be sure to read it.
- MEMO** It indicates a memo regarding the setting or function; It's up to you read it.
- TIPS** It indicates a useful hint for operation; read it as necessary.

Contents

| | |
|--|----|
| Important Safety Instructions | 5 |
| Relevant Indications | 7 |
| Panel Description | 10 |
| Connections Quick Guide | 13 |
| Quick Guide | 14 |
| Before You Start to Play | 17 |
| Connecting the AC Adaptor | 17 |
| Connecting External Audio Amplifier | 17 |
| Connecting the Pedals | 17 |
| Listening Through Headphones | 18 |
| Connecting Digital Player Devices | 18 |
| Connecting the S9 to Your Computer | 18 |
| Connecting the S9 to an USB MIDI Keyboard (USB host function) | 19 |
| Connecting the S9 to MIDI devices | 19 |
| Connecting an USB Memory (commercially available) | 19 |
| Safely Remove the USB Memory | 19 |
| Installing Music Rest | 20 |
| Ground Terminal | 20 |
| Turning the Power On | 20 |
| Turning the Power Off | 20 |
| Demo of the S9 | 21 |
| Basic Operation | 22 |
| About the Display and Cursor Operation | 22 |
| Main Page | 22 |
| Moving the Cursor and Setting Parameter Values | 23 |
| Assigning the Name You Specify | 23 |
| Selecting Tones | 24 |
| How to Select Tones | 24 |
| Most Frequently Used Tones (Favorite Tone) | 24 |
| Playing Two Sounds Over the Entire keyboard (Layer) | 24 |
| Splitting the Keyboard Range and Playing Two Different Tones (LOWER) | 25 |
| Adding the PEDAL Part | 25 |
| Special Pedalboard Tones: "Pedal Bass" and "Pedal DoublBs" | 26 |
| Play All Parts in Layer Mode | 26 |
| How to change the Split Point | 26 |
| Adjust the Volume and Reverb for Each Part by the Draw Faders | 26 |
| Tone MIDI Information | 27 |
| Organ Section | 28 |
| Selecting Various Organ Types | 28 |
| Selecting Presetted Organ Sounds | 28 |
| Motorised Draw-faders | 29 |
| Altering the Sound using Draw-faders | 29 |
| Assigning the Draw-faders (TW ASSIGN) | 29 |
| Useful Draw-faders Movement Functions (Morphing) | 29 |
| Applying Vibrato/Chorus Effect | 30 |
| Adding Overdrive Effect | 30 |
| Editing Overdrive Parameter | 31 |
| Adding Harmonic Percussion | 31 |
| Adding Rotary Effect | 31 |
| Adding Effects to Orchestral Sound | 32 |
| Going Around Sound Effects | 32 |
| FX Real-time Controls | 32 |
| Selecting a Sound Effect to the Part | 32 |
| Adding Reverb to the Sound | 32 |
| Adjust the Reverb for Each Part by the Draw Faders | 33 |
| Other Functions | 34 |
| Transposing the pitch of the keyboard | 34 |
| Shifting the Tuning of a Keyboard Part in Octave Steps | 34 |
| Aftertouch | 34 |
| Assigning a function | 34 |
| Performing Musical Chords | 35 |
| Chord Enhancer | 35 |
| Chord Freeze | 35 |
| Adjusting the Keyboard Response (Key Touch) | 35 |
| Customize the Global Keyboard Response (Key Touch) | 35 |
| Adjusting the AUDIO IN Input Level | 36 |
| Restoring the Factory Settings (Factory Reset) | 36 |
| Restore the Factory Sounds | 36 |
| Sound Library | 37 |
| Remove and Add Sound Libraries | 37 |
| Removing a Sound Library | 38 |
| How To Load Sound Libraries in a USB Memory | 38 |

| | |
|--|----|
| Adding a Library | 38 |
| How to Select USER Sounds | 39 |
| How to Select USER Organ Sounds | 40 |
| How to Select USER Orchestral Sounds | 40 |
| Sound Setup (Export/Import) | 41 |
| Exporting a Sound Set ("EXPORT SETUP") | 41 |
| Importing a Sound Set ("IMPORT SETUP") | 41 |
| Personalizing Your Sounds (T2L) | 42 |
| Making Slight Additions or Sound Alterations | 42 |
| Parameters to be edited | 42 |
| Orchestral Sounds Parameters | 43 |
| Tonewheel parameters | 44 |
| Adjusting the Keyboard Velocity Response According to the Sound | 45 |
| Working with the Memories | 47 |
| About the Memories and Memory Set structure | 47 |
| Saving Your Settings in the Internal Memory | 47 |
| Recalling your Settings from Internal Memory | 47 |
| Saving Your Settings in the USB Memory (commercially available) | 47 |
| Recalling your settings from an USB Memory | 49 |
| Renaming a Memory | 49 |
| Exporting All Internal Memories in a Set in the USB Memory | 49 |
| Importing a Memory Set from the USB Memory | 50 |
| How to Automatically Recall Your Favorite Setting at the Power On | 50 |
| Playing a Music Audio File | 51 |
| Before Playing Songs | 51 |
| Copying Audio Files to an USB Memory | 51 |
| Selecting and Playing a Song | 51 |
| Useful Song Controls | 52 |
| Recording Your Performance | 53 |
| Recording Your Music as Audio Data (WAVE) | 53 |
| How to Record your Performance over an Existing Audio Song (Overdub) | 53 |
| Master Keyboard Zone | 54 |
| Programmable Four MIDI zones | 54 |
| Configure the MIDI zones | 54 |
| Playing with Audio Backing Tracks | 56 |
| Connecting your Mobile Device | 56 |
| Playing with X MURE Application | 56 |
| Wireless Function | 57 |
| Bluetooth® Audio Connectivity | 57 |
| Preliminary Operation, Pairing a Mobile Device | 57 |
| Connecting an Already Paired Mobile Device | 58 |
| Master Equalizer | 59 |
| Real Time Control | 59 |
| Master Equalizer Adjusting | 59 |
| Master Equalizer Preset | 59 |
| Saving Your User Preset | 60 |
| MENU Options (Advanced Section) | 61 |
| General procedure | 61 |
| SETTING Parameters Group | 62 |
| T2L EDITOR | 63 |
| EFFECT | 63 |
| CONTROL | 63 |
| TUNING | 66 |
| MEMORY | 67 |
| USB REMOVE | 67 |
| USB AUDIO | 68 |
| AUDIO INPUT | 68 |
| BLUETOOTH | 68 |
| MIDI | 68 |
| GLOBAL | 70 |
| SOUND LIBRARY | 71 |
| SOUND SETUP | 71 |
| FACTORY RESET | 71 |
| FACTORY SOUND | 71 |
| VERSION INFO | 71 |
| Appendix | 72 |
| Effects Types and Parameters List | 72 |
| S9 Orchestral Tones List | 75 |
| Draw-faders MIDI Controls | 76 |
| Troubleshooting | 77 |
| Specifications | 78 |
| Index | 79 |

3 Panel Description

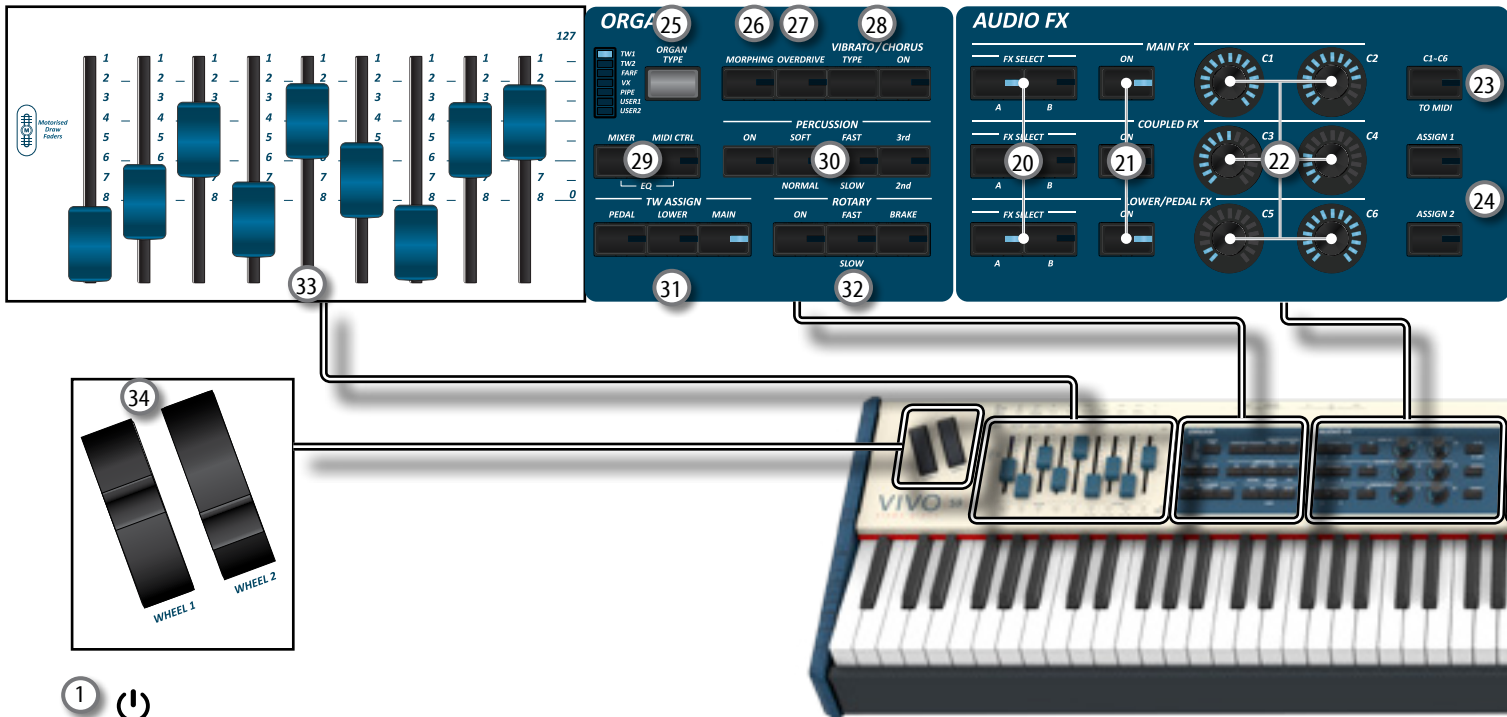

1

Turns the power on or off (p. 20).

With the factory settings S9's power will automatically be switched off 120 minutes after you stop playing or operating the S9.

If S9's power has been turned off automatically, you can use the switch to turn the S9 back on. If you don't want the power to turn off automatically, set the "AUTO OFF" parameter to "OFF" (p. 70).

NOTE

To avoid malfunctions, never disconnect the AC/DC adapter while the instrument is turned on.

2 **VOLUME**

Use this knob to set S9's overall volume.

3 **SOUND LIBRARY**

Press this button to access the Sound Libraries environment.

4 **CHORD ENHANCER and CHORD FREEZE**

The [ENHANCER] button enable the Enhancer function. This function improve the sound adding notes to the played chord. See "Performing Musical Chords" (p. 35). The [FREEZE] button to enable the Freeze function and memorize the chord played in the keyboard in that moment. From now on and until the function is active, whenever you press a note in the keyboard the chord memorized will be reproduced with the same tonality of the played note. For details see p. 32.

NOTE

The Chord Enhancer function works when a not percussive tone is selected . See the sounds table "S9 Orchestral Tones List" (p. 75).

5 **PLAYER section**

Press the [SONG] button to switch in Song Mode. See p. 51.

Press it together with the button to listen the demo song.

Press the button to start playing. Press it again to stop playing (See p. 56).

Press the button to start recording of your song (See p. 53).

6 **OCTAVE**

This button calls up the octave function. See p. 34.

7 **TRANPOSE**

This button calls up the transposition function. See p. 34. If the button indicator doesn't light the instrument use its normal pitch.

8 **AFTERTOUCH**

Press this button to enable the Aftertouch function. This function lets you modify the sound by applying additional pressure to the key. Press and hold this button to open the Aftertouch page and edit the parameters. See p. 34.

9 **SOUND**

When this button is active (it's lit), you can select sounds by the bank and number buttons.

10 **MEMORY/WRITE**

When this button is active (it's lit), you can select memories by the bank (Family Tone buttons) and number buttons. Press and hold this button to write a memory. See p. 47.

11 **BANK/NUMBER buttons**

These buttons allow you to select sounds and memories. When the [SOUND] button is active (it's lit), the first row select the sounds families and the second row select the sound number. See p. "How to Select Tones" (p. 24).

When the [MEMORY] button is active (it's lit), the first row select the bank of memories and the second row select the number. See "Working with the Memories" (p. 47).

12 **Keyboard Mode Section**

Use the [PEDAL] and the [LOWER] buttons to split the keyboard and to play the relative part with your left hand. Use the [MAIN] button to select the Main part.

Use the [COUPLED] button to add the coupled part.

13 **MASTER KEYBOARD ZONE (A, B, C, D)**

These buttons allows you to manage the Master Keyboard Zone functions. See p. 54.

Press and hold one of the buttons to access the edit page.

14 **T2L**

Press this button to open the T2L page and personalize the tones of the instrument.

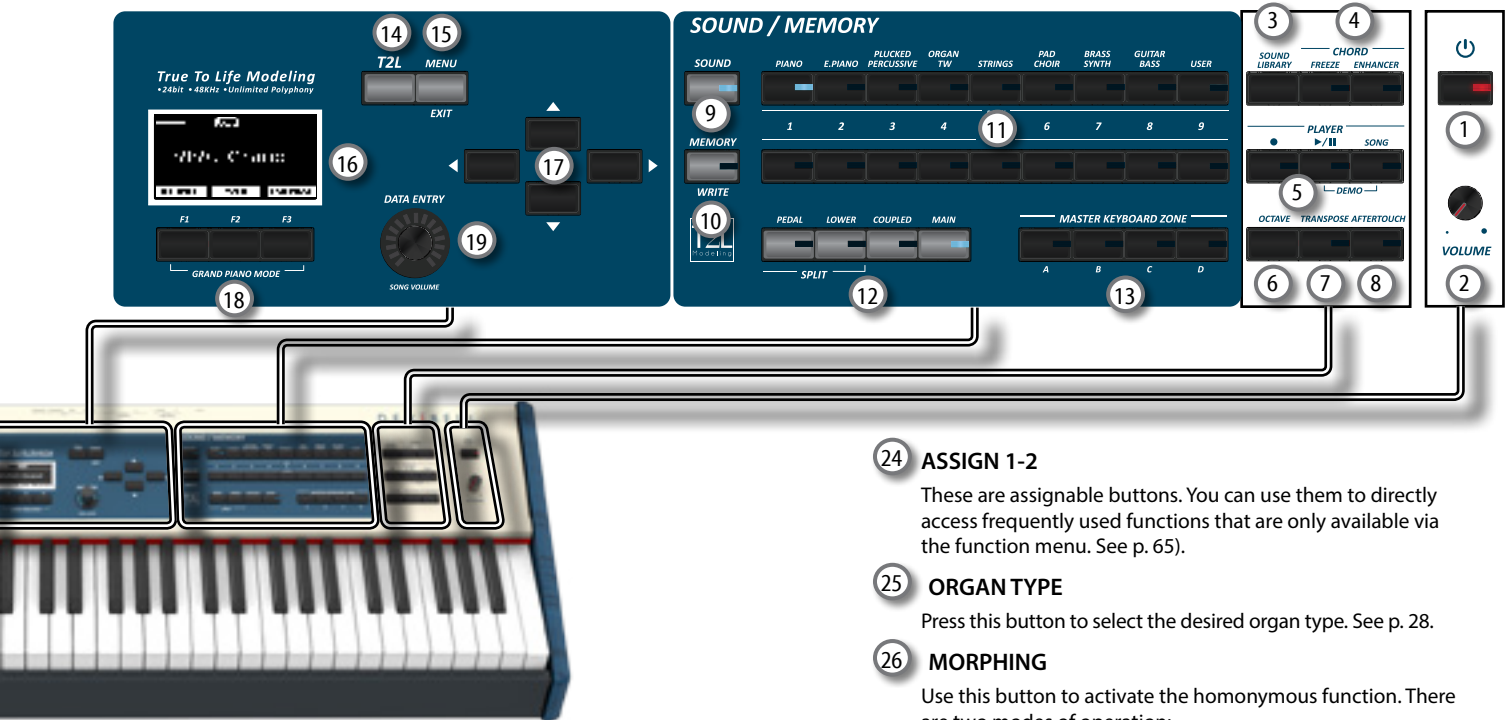

15 MENU/EXIT

This button allows you to open and close the menu page where you can view and select all available functions.

16 DISPLAY

This display shows information related to your operation. The last row of the display shows the functions that you can recall pressing one of three function button (F1, F2, F3) below the display.

17 Arrow buttons

These buttons are used to navigate around the various menus, adjust the parameters value.

18 Function buttons (F1, F2, F3)

These buttons are used to select one of three functions/options shows at the bottom of the display.

19 DATA ENTRY/SONG LEVEL

When a parameter is selected this knob works as Data Entry. When the instrument is in song mode this knob allows you to set the volume of the song player.

20 FX SELECT A/B (Main Fx, Coupled Fx, Lower/Pedal Fx)

Use these buttons to select which AUDIO FX processor (A or B) you want to control for the Main, Coupled and Lower/Pedal part. The [ON] buttons and the (C1-C2, C3-C4, C5-C6) control knobs are assigned to the AUDIO FX processor you selected (A or B).

21 ON (Main Fx, Coupled Fx, Lower/Pedal Fx)

Use these buttons to switch ON/OFF the AUDIO FX processors for the relative parts (Main, Coupled and Lower/Pedal). Use the [FX SELECT A] or the [FX SELECT B] buttons to select the AUDIO FX processor you want to control.

22 C1-C2, C3-C4, C5-C6 control knobs

Use these control knobs to adjust the parameter value of the effect related to the current tone. Use the [FX SELECT A] or the [FX SELECT B] buttons to select the AUDIO FX processor you want to control.

23 C1~C6 / TO MIDI

This button allows you to enable the control knobs C1~C6 to send MIDI messages to control external MIDI devices.

24 ASSIGN 1-2

These are assignable buttons. You can use them to directly access frequently used functions that are only available via the function menu. See p. 65).

25 ORGAN TYPE

Press this button to select the desired organ type. See p. 28.

26 MORPHING

Use this button to activate the homonymous function. There are two modes of operation:

- **AUTO** - When you recall a tonewheel, the position of the draw-faders is not achieved immediately, but within a specific time. See p. 29.
- **PEDAL** - The transition between two different combinations of draw-faders (FROM, TO) is performed by the movement of the expression pedal connected to the ASSIGN 3 (morphing) socket. See p. 29.

27 OVERDRIVE

Press this button to active a natural-sounding distortion typical of a vacuum tube amplifier. You can modify some parameters related to this effect. See p. 30.

28 VIBRATO/CHORUS section

Use this section to adjust the vibrato and chorus effect.

Press [TYPE] to select the type of effect.

Press [ON] button to enable or disable the effect.

29 MIXER, MIDI CTRL

Use these button to selects the groups of parameters (Mixer, MIDI or EQ) that is controlled by the 9 draw faders.

By pressing these two buttons simultaneously, you can control the EQ parameters.

30 PERCUSSION section

Use this section to add the classic crisp attack unique to the vintage organ. See p. 31.

31 TW ASSIGN section

Here you can select which part (PEDAL/LOWER/MAIN) is assigned to the draw-faders. This selection is useful while editing or playing live.

32 ROTARY section

Use this section to simulate the sound of classic rotary speakers from the past. See p. 31.

33 Motorised Draw-faders

The 9 draw-faders are used to adjust the volume of each footage. Each draw-fader is labelled with the numbers 1 - 8 along the flat part of the draw-fader. When recalling a presetted tonewheel or a memory, the draw-faders physically will move to reach the new position. See p. 29.

34 WHEEL 1, WHEEL 2

Move these wheel forward or backward to modify the value of the assigned parameter. At default the WHEEL 1 is assigned to the Pitch and the WHEEL2 to the Modulation. To assign another parameter to these controllers see p. 65.

Rear Side

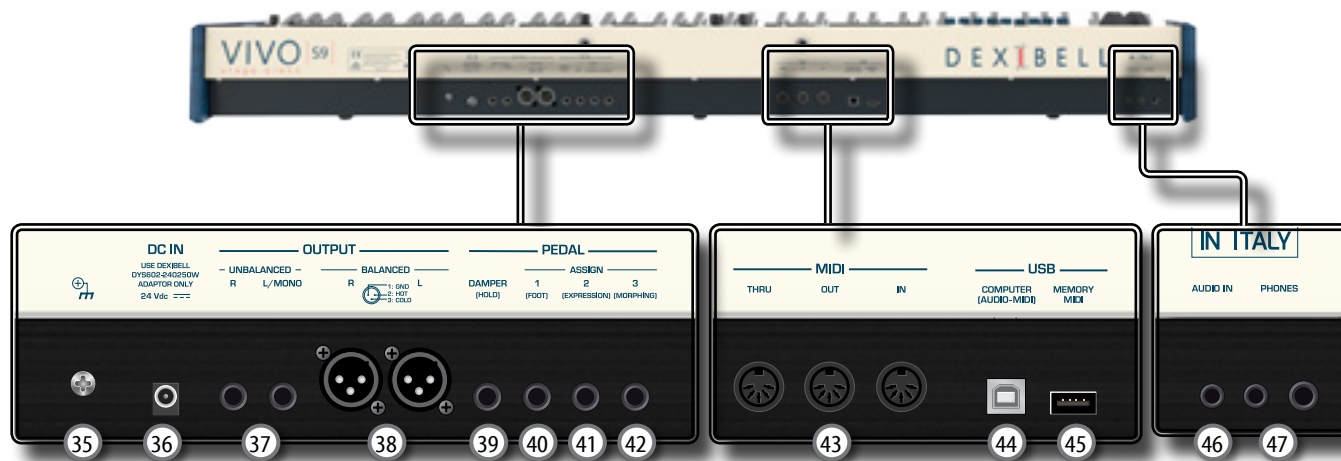

35 Ground terminal

Depending on the circumstances of a particular setup, you could feel a tingling sensation at the point where you touch this device.

You can eliminate this sensation connecting the ground terminal with an external ground. For details see p. 20.

36 DC IN socket

Connect the supplied AC/DC adaptor here (p. 17).

NOTE

Be sure to use only the AC adaptor (DEXIBELL DYS602-240250W) supplied with the unit. Also, make sure the line voltage at the installation matches the input voltage specified on the AC adaptor body. Other AC adaptors may use a different polarity, or be designed for a different voltage, so their use could result in damage, malfunction, or electric shock.

37 UNBALANCED OUTPUT R, L/MONO sockets

These TS sockets allow you to connect powered speakers or amp (p. 17). Both TS type and XLR (17) type jacks output the same audio.

38 BALANCED OUTPUT R, L sockets

These XLR sockets allow you to connect mixer, powered speakers or amp (p. 17). Both XLR type and TS (35) type jacks output the same audio.

39 DAMPER (HOLD) pedal

Use this pedal to sustain the sound (p. 17).

NOTE

We suggest to connect at this socket a continuous pedal controller. In this way you can appreciate all the musical nuances of a continuous controller.

40 ASSIGN 1 [FOOT] pedal

Connecting an optional foot switch to this socket allows you to control an assignable function by foot. See p. 17

41 ASSIGN 2 [EXPRESSION] pedal

Connecting a commercially available pedal to this socket allows you to control an assignable function by foot (p. 64).

This socket automatically recognize an expression pedal connected setting the Expression function, regardless of the current function assigned.

42 ASSIGN 3 [MORPHING] pedal

Connecting a commercially available pedal to this socket allows you to control an assignable function by foot (p. 64).

At default, you can use this pedal to drive the transitions between two different combinations of draw-faders (MORPHING). See p. 16.

43 MIDI THRU/OUT/IN sockets

These sockets allow you to connect the S9 to external MIDI devices to transmit and receive MIDI messages. See p. 18. The IN socket allows you to connect a commercial available pedal unit so as to play the pedal section with your feet. If you connect a pedal unit here, the PEDAL section becomes polyphonic.

44 USB Computer Port

Use an USB cable to connect the S9 to your computer via this connector p. 18.

45 USB Memory Port

Connect an commercially available USB Memory here.

If you connect to this port an USB MIDI keyboard or modules you can exchange MIDI data without a computer and without using two MIDI cables. See "Connecting the S9 to an USB MIDI Keyboard (USB host function)." (p. 19).

NOTE

* Carefully insert the USB Memory making sure that the connector on the device is appropriate and that it is connected in the proper direction.

* Dexibell does not recommend using USB hubs, irrespective of whether they are active or passive. Please connect only one USB Memory to this port.

46 AUDIO IN socket

This mini jack allows you to connect the audio outputs of an external signal source (CD/mp3 player, etc.).

47 PHONES outputs

This is where you can connect one or two pairs of optional headphones.

4 Connections Quick Guide

Peripheral Devices

NOTE

Before to connect any external device to Audio IN socket, rotate the [VOLUME] knob counterclockwise to minimize the volume.

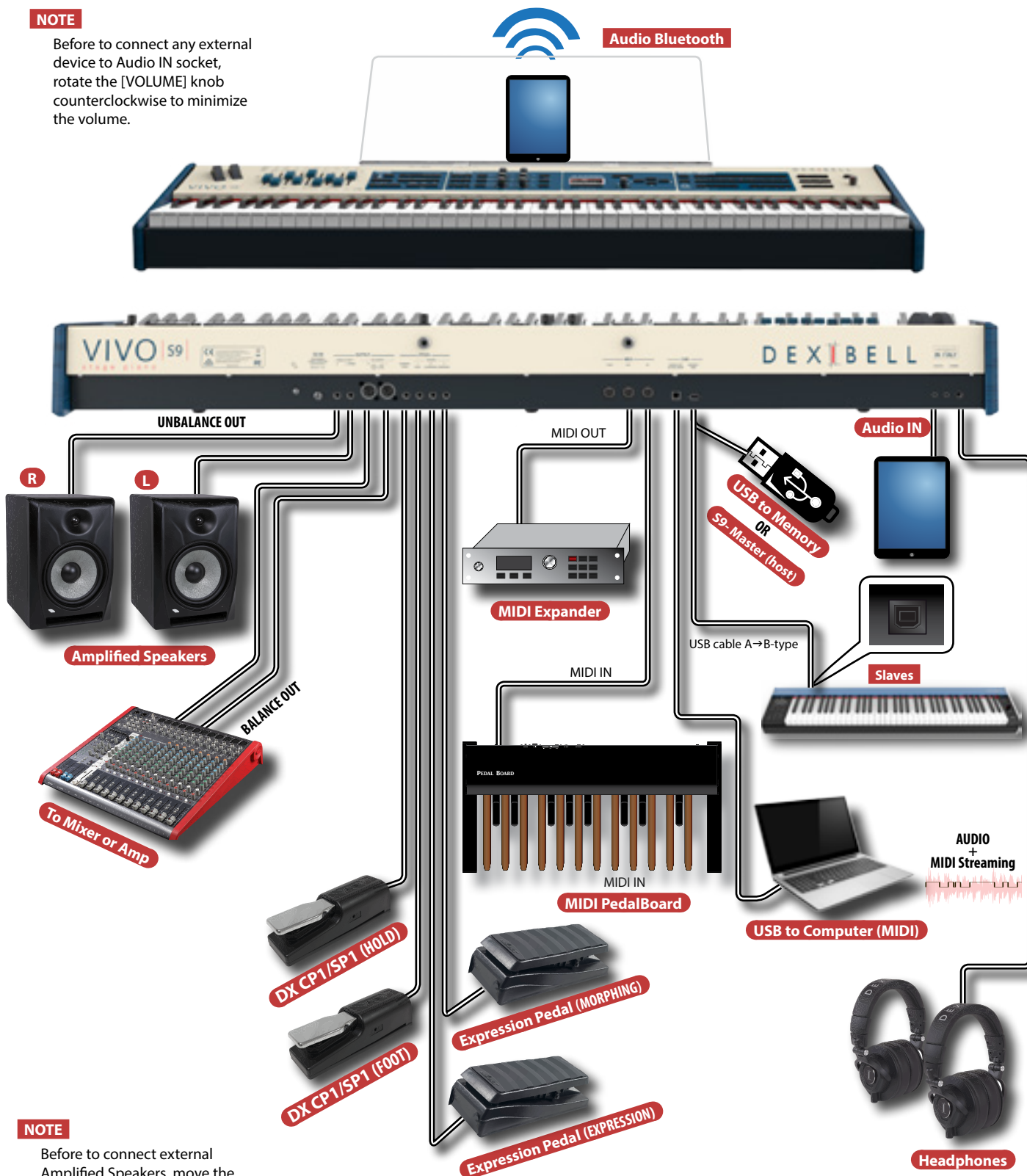

NOTE

Before to connect external Amplified Speakers, move the [VOLUME] slider toward the lower position to minimize the volume.

5 Quick Guide



The Motorised Draw-faders

Use these draw-faders in real time to create a variety of tonalities sliding them up and down. When recalling a presetted tonewheel or a memory, the draw-faders physically will move to reach the new current position. The display shows the numbers of each footage.

Select an Organ Type

The S9 reproduces the tonal characteristics of famous vintage organs. The "USER 1" and "USER 2" allow you to import sounds set downloadable from www.dexibell.com site.

1. Press the button repeatedly until the indicator of the desired organ type lights.

Add Overdrive Distortion

This function add a natural-sounding distortion as heard from a tube amp.

1. Press the [OVERDRIVE] button to activate the distortion. Its indicator lights.

Add Vibrato & Chorus

1. Press the [ON] button to activate the effect.
2. Press the [TYPE] button to select type of effect (V1, C1, V2, C2, V3, C3 and TREMULANT 1 ~ 6 only for the pipe organ sound).

Add Percussion to the Sound

The S9 give you the possibility to emulate the percussive sounds typical of vintage organ.

1. Press the [ON] button to activate percussion to the sound.
2. Pressing the "SOFT" button the percussion sound will be softer.
3. Pressing the "FAST" button the percussion sound will decay immediately, producing a sharper attack.
4. Press the [3rd/2nd] button to select between the third (the indicator lights) or second harmonics

Add Rotary Effect to the Sound

By this section you turn it on or off the Rotary effect. This effect simulates the typical sound modulation generated by a cabinet with rotating loudspeakers.

1. Press the [ON] button to add the rotary effect. Its indicator lights.
2. Press the [FAST/SLOW] button to select between the fast (the indicator lights) or slow speed.
3. Press the [BRAKE] button to stop the rotation of the rotary.

Adjusting by Draw-faders

You can control groups of parameters (Mixer, MIDI or EQ) by the Draw-faders.

1. Press the [MIXER] or [MIDI CTRL] button to control the related parameters group by Draw-faders.
2. To control the Master Equalizer parameters group press these two buttons simultaneously.

Assigning the Draw-faders

You can select organ sounds for the MAIN, LOWER and PEDAL keyboard parts. It's evident that only one part at the time can be assigned to the draw-faders section.

1. Press the [MAIN], [LOWER] or [PEDAL] button to assign the keyboard part to the draw-faders section.

Morphing Function

By this button you can manage some useful functions related to the movement of the draw-faders.

1. Press the [MORPHING] button to activate the function. For details please refer to the appropriate section.

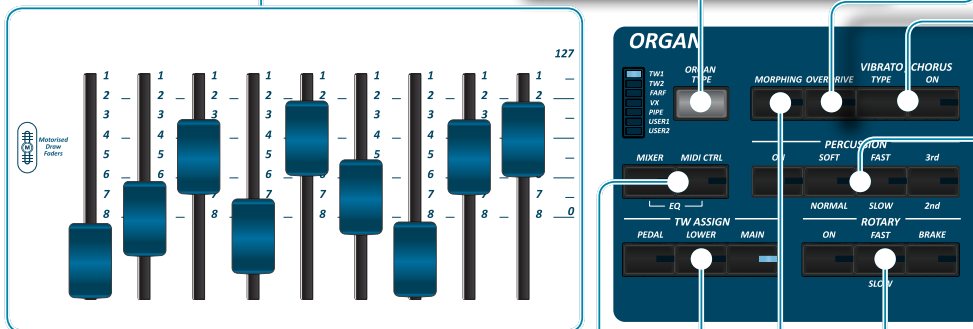

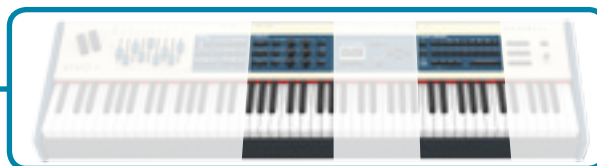

Effects for Orchestral Sounds

You have two AUDIO FX processor for each part (MAIN, COUPLED and LOWER/PEDAL).

1. Use the [FX SELECT] buttons to select which AUDIO FX processor (A or B) you want to control for the Main, Coupled and Lower/Pedal part. The buttons [ON] and the control knobs (C1-C2, C3-C4, C5-C6) are assigned to the AUDIO FX processor you selected (A or B).
2. Use the [ON] buttons to switch ON/OFF the AUDIO FX processors for the relative parts (Main, Coupled and Lower/Pedal).
3. Use the C1/C2, C3/C4, C5/C6 control knobs to adjust the parameter value of the effect related to the current tone.

Controlling External Devices

1. Press the [C1~C6 / TO MIDI] button to control external MIDI devices by the control knobs C1-C6.

Assignable buttons

You can use them to directly access frequently used functions that are only available via the function menu.

Selecting a Tone

1. Press [SOUND] button.
2. Press one of buttons of the sounds family to recall a new tone.
3. Press one of the [1] to [9] button to select another sound in same the family.

HOW TO SET THE SELECTED TONE AS FAVORITE

1. Press and hold the same Sound number button previously pressed.

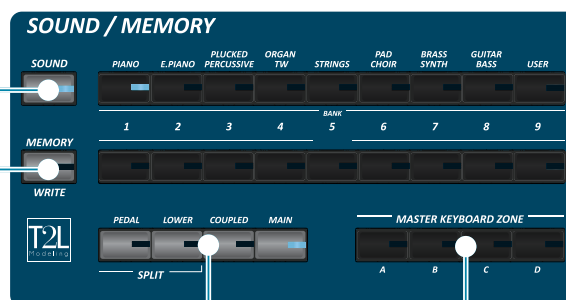
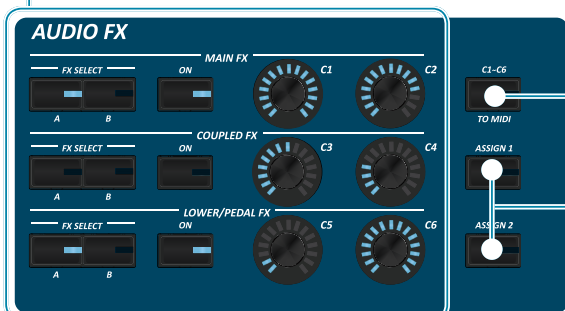

Favorite Settings

HOW TO MEMORIZE YOUR FAVORITE SETTING

The S9 allows you to memorize your favorite settings for easy recall whenever they're needed. Up to 81 complete setups can be saved.

1. Press and hold the [MEMORY/WRITE] button to call up the memories page (its indicator flashes).
2. Use the bank (Sound Families) and number buttons to select the position you want to replace the Memory.
3. Press the function button that shows "SAVE" at the bottom of the display.
4. Use the [DATA ENTRY] and [◀] [▶] buttons to enter the desired name.
5. To confirm press the function button that shows "OK" at the bottom of the display.

HOW TO RECALL YOUR FAVORITE SETTING

1. Press the [MEMORY] button to call up the memories page.
2. Use the bank (Sound Families) and number buttons to select the memory location.

Specifying the Keyboard Part

1. Press the relative button to specify the part you wish to assign to the keyboard.

If you press the [PEDAL] or [LOWER] button the keyboard is automatically splitted. See the parameter "SPLIT OFF" to use all parts in layer mode..

Master Keyboard Function

The S9 has four programmable separated MIDI zones. For each zone you can select the MIDI channel, the keyboard range, adjust the octave, transpose and many other parameters.

1. Press the relative button to specify the zone you wish to assign to the keyboard.
2. Press and hold one of the KEYBOARD ZONE buttons to access the edit page

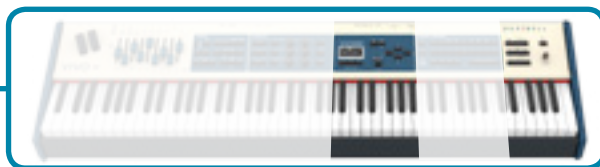

Managing the Song Library

The S9 give you the possibility to install new sounds and manage existing ones.

1. Press the [SONG LIBRARY] button to access the Sound Libraries environment.

CHORD ENHANCER and CHORD FREEZE

[CHORD ENHANCER]

This function improves the sound of the adding notes to the played chord. The Chord Enhancer function works when a not percussive tone is selected. See the Orchestral Sound List.

1. Select a not percussive sound. See the sounds table "S9 Orchestral Tones List" (p. 75).
2. Press the CHORD [ENHANCER] to activate the function (its indicator lights).
3. Play a chord on the keyboard. The Chord Enhancer function adds notes to the chord you played.

[CHORD FREEZE]

The Chord Freeze allows you to memorize a complex chord and play it in different tonality on the keyboard using a finger only.

1. Playing and holding the chord (at least two notes) on the keyboard that you want "Freeze", press the CHORD [FREEZE] button. Its indicator lights.
2. Play a note on the keyboard with the desired tonality. The chord previously memorized is reproduced with the same tonality of the played note.

Record and Playback a Song

1. Press the [RECORD] button to start recording.
2. Play your song.
3. Press the [RECORD] button to stop recording.
4. Press the [PLAY/PAUSE] button to listen your recording.
5. Press the [PLAY/PAUSE] button again to pause the song.

Song Mode

1. Press the [SONG] button to enter in SONG mode (Its indicator lights).
2. Press the "SONG LIST" F2 function button. The display shows the contents of the Song internal memory.

Change the Keyboard Octave

The Octave function allows you to change the pitch of the selected part in octave steps.

1. Press the [OCTAVE] button.

Transposing the Keyboard

1. Press the [TRANPOSE] button to call up the page where you can change the transposition value.
2. Use the [DATA ENTRY] knob or the [LEFT] [RIGHT] buttons to change the value.

Managing the Aftertouch

This function that lets you modify the sound by applying additional pressure to the key.

1. Press the [AFTERTOUCH] button to enable the Aftertouch function. Its indicator lights.
2. Press and hold the [AFTERTOUCH] button to open the Aftertouch page to edit the parameters.

T2L Editor

1. Press this button to open the T2L page and personalize the sounds of the instrument.

Menu/Exit button

1. Press this button to open and close the menu page where you can view and select all available functions.

Function Buttons

1. Press these buttons to select functions/options shows at the bottom of the display.

Data Entry/Song Volume

When a parameter is selected this knob works as Data Entry. When the instrument is in song mode, this knob allows you to set the volume of the song player.

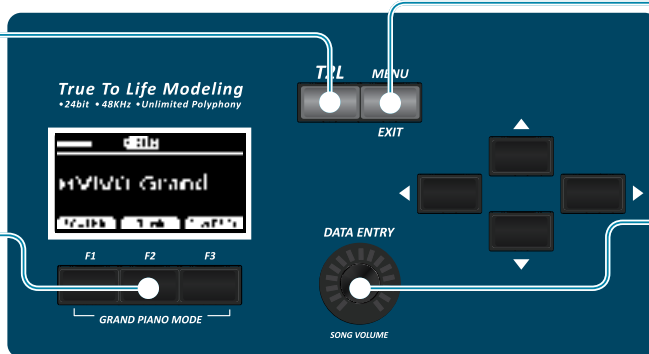

6 Before You Start to Play

Connecting the AC Adaptor

1. Rotate the [VOLUME] knob toward the left position to minimize the volume.
2. Connect the included power cord to the AC adaptor.



The indicator will light once you plug the AC adaptor into a wall outlet.



NOTE

Depending on your area, the included power cord may differ from the one shown above.

NOTE

Be sure to use only the AC adaptor (DEXIBELL DYS602-240250W) supplied with the unit. Also, make sure the line voltage at the installation matches the input voltage specified on the AC adaptor body. Other AC adaptors may use a different polarity, or be designed for a different voltage, so their use could result in damage, malfunction, or electric shock.

NOTE

If you won't be using the S9 for an extended period of time, disconnect the power cord from the electrical outlet.

NOTE

To avoid malfunctions, never disconnect the AC/DC adapter while the instrument is turned on.

3. Connect the AC adaptor to the S9's DC IN jack positioned to the rear bottom panel. Secure it manually screwing the ring nut to the DC IN socket.

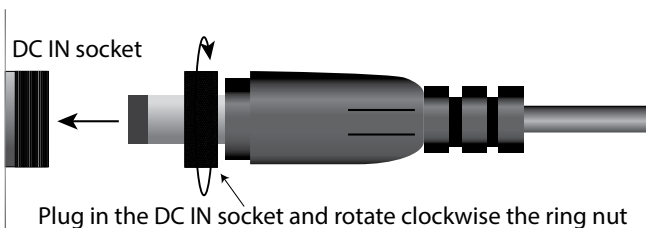

Plug in the DC IN socket and rotate clockwise the ring nut

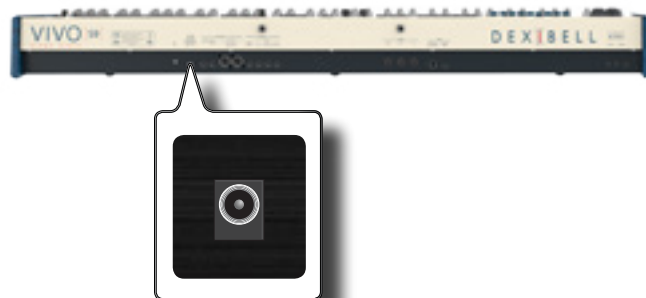

Connecting External Audio Amplifier

You can connect the unbalanced or balanced OUTPUT R/L/MONO jacks to an external amplifier, mixing consoles, etc. Both, XLR type and TS type jacks output the same audio.

NOTE

If you want to use only one channel on your external amplifier, connect the L/MONO socket to its input. For optimum sound quality, we recommend working in stereo, though.

1. Rotate the [VOLUME] knob toward the left position to minimize the volume.
2. Connect the S9's OUTPUT jacks to the inputs of your external audio device.

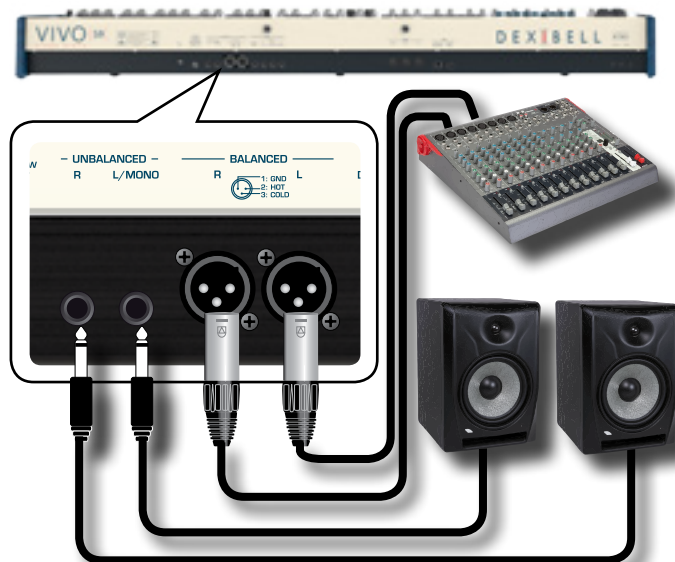

Connecting the Pedals

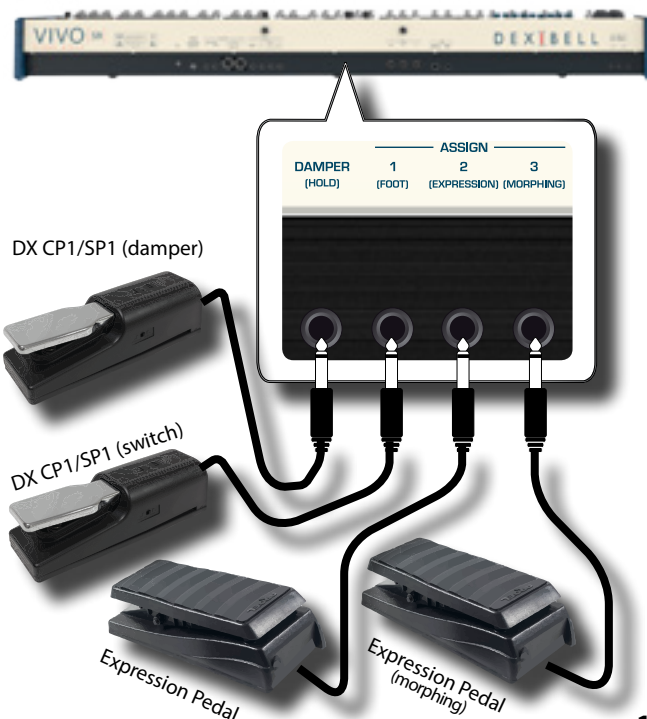

1. Connect a sustain pedal to the DAMPER (HOLD) socket.
This is the most commonly used pedal in percussive instruments. When the pedal is pressed, all notes played will continue to sound until the vibration naturally ceases.

2. Connect a foot-switch to the ASSIGN 1 socket.
An optional foot-switch connected to the ASSIGN 1 socket can be used to perform various functions. For detail see "PEDAL SETTING" (p. 63).

NOTE

The ASSIGN 1 socket accepts foot-switches ON/OFF type only.

3. Connect an expression pedal to the ASSIGN 2 (EXPRESSION) socket.
You can control the volume of the Organ, Orchestra and Piano sections.
The EXPRESSION socket is assignable in a way that various functions can be assigned to it. For detail see "PEDAL SETTING" (p. 63).

4. Connect an expression pedal to the ASSIGN 3 (MORPHING) socket.
If the Morphing function is active, you can use an expression pedal to drive the transitions between two different combinations of draw-faders (MORPHING). See "Useful Draw-faders Movement Functions (Morphing)" (p. 29).

Listening Through Headphones

You can use headphones to enjoy the S9 without disturbing those around you.

1. Here you can connect stereo headphones. The S9 has two headphones jacks . Two people can use headphones simultaneously.

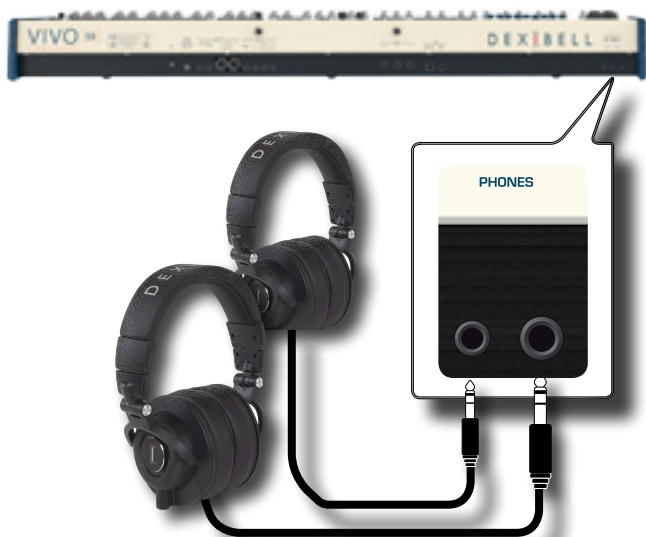

2. Rotate the S9's [VOLUME] knob to adjust the volume of the headphone.

Cautions when using headphones

- To prevent damage to the cord's internal conductors, avoid rough handling. When using headphones, mainly try to handle either the plug or the headset.
- Your headphones may be damaged if the volume of a device is already turned up when you plug them in. Minimize the volume before you plug in the headphones.
- Excessive input will not only damage your hearing, but may also strain the headphones. Please enjoy music at a reasonable volume.

Connecting Digital Player Devices

You can connect the INPUT mini jack to an audio playback device.

- 1. Rotate the [VOLUME] knob toward the left position to minimize the volume.**
- 2. Connect the S9's AUDIO IN mini jack to the output of an external signal source.**



3. To adjust the input level the S9's AUDIO IN, press the [MENU] button and select the AUDIO INPUT function.

Connecting the S9 to Your Computer

If you use a USB cable (commercially available) to connect the USB COMPUTER port on the S9's rear panel to your computer's USB connector, you can record and play audio and/or MIDI data by your MIDI software (DAW software).

NOTE

To use the USB audio streaming you need of a computer equipped with MAC OSX or LINUX, an iPad or iPhone.

NOTE

The S9 does not support GM/GS standard.

1. Use a standard USB cable (A→B-type connectors, commercially available) to connect the S9 to your computer as shown below.

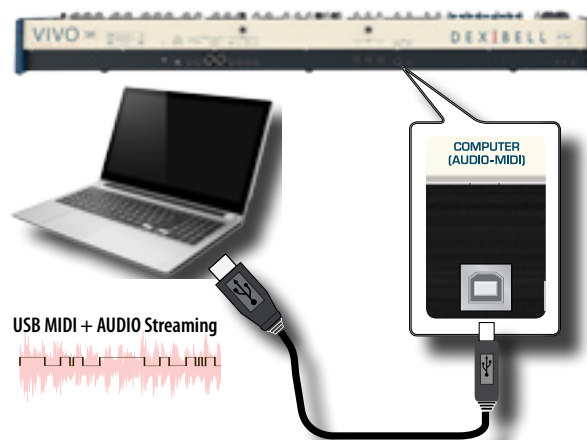

NOTE

- Switch on the S9 before you start up the DAW software on your computer.
- Before to connect any other equipment, move the [VOLUME] knob counterclockwise to minimize the volume.
Now, the same sound of the S9's audio OUTPUT (unbalanced or balanced) can be recorded into your computer and the sound from

Connecting the S9 to an USB MIDI Keyboard (USB host function)

your computer can be played from audio system connected to the S9's audio OUTPUT jacks.

Connecting the S9 to an USB MIDI Keyboard (USB host function)

Using the following connection, your keyboard becomes a master (host). You can connect other keyboards or modules from any brand directly to the DEXIBELL USB "Memory" port and exchange MIDI data without a computer and without using two MIDI cables.

The connection consists of the following main components:

- Your DEXIBELL keyboard.
- One slave MIDI USB Device as a keyboard.
- A physical bus represented by the USB cable that links the devices with the host.

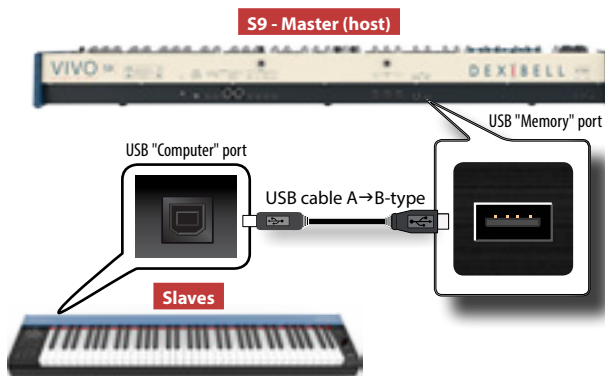

Connecting the S9 to MIDI devices

MIDI is a universal standard, which means that musical data can be sent to and received by instruments of different types and manufacturers. MIDI allows you to connect your instrument to another device as an MIDI sound module.

Here below an example of MIDI connection:

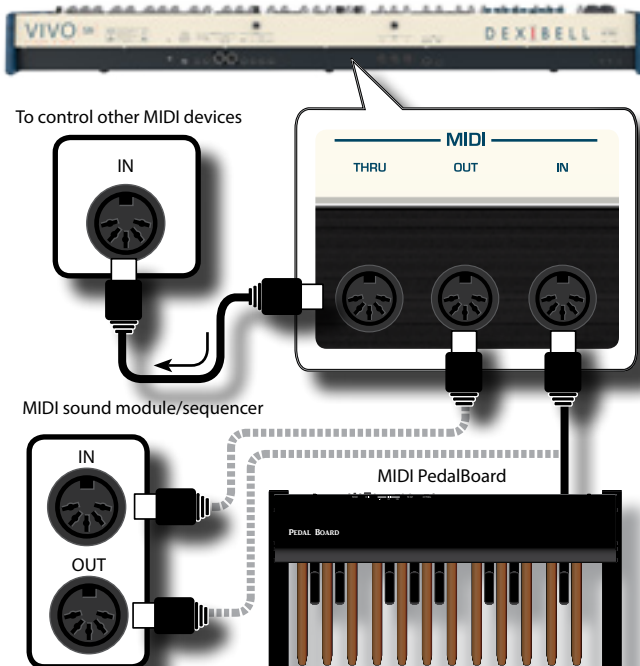

1. Use an optional standard MIDI cable (code: CHL400LU15) to connect the S9 MIDI OUT socket to the MIDI IN socket of the external MIDI device.

2. If necessary, use an optional standard MIDI cable (code: CHL400LU15) to connect the MIDI OUT socket of the external device to the S9 MIDI IN socket.
3. If you need to re-send the MIDI messages received by the S9 OUT socket to another device, connect the THRU socket using an additional MIDI cable (code: CHL400LU15) to the relative MIDI IN socket.

For details on MIDI settings of the external device, refer to its owner's manual.

Connecting an USB Memory (commercially available)

1. As shown in the illustration, connect an USB Memory to the MEMORY port.

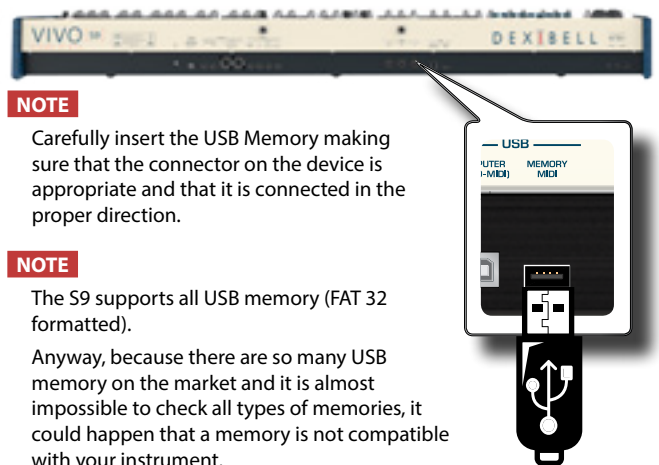

NOTE

Carefully insert the USB Memory making sure that the connector on the device is appropriate and that it is connected in the proper direction.

NOTE

The S9 supports all USB memory (FAT 32 formatted).

Anyway, because there are so many USB memory on the market and it is almost impossible to check all types of memories, it could happen that a memory is not compatible with your instrument.

Safely Remove the USB Memory

IMPORTANT

You should always safely eject the USB Memory before physically unplugging it from USB socket. Before to unplug the USB Memory use the "USB REMOVE" function.

1. Press the [MENU/EXIT] button.



2. Use the [▲] [▼] buttons to scroll the list and select the "USB REMOVE" function.

3. Press the [▶] buttons to access the function.

The display shows:



1. Press the "YES" Function button to safely remove the USB Memory.

Now you can unplug the USB Memory safely.

Installing Music Rest

Install the included music rest as shown in the illustration below.

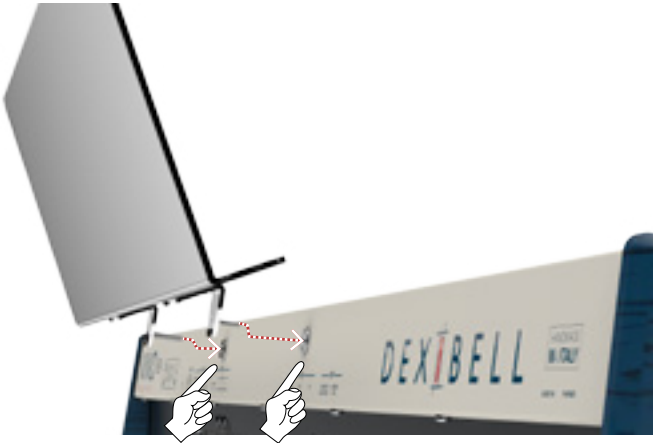

Ground Terminal

Depending on the circumstances of a particular setup, you could feel a tingling sensation at the point where you touch this device.

You can eliminate this sensation connecting the ground terminal with an external ground.



1. Use the screw-type ground terminal to connect to ground or to connect to the chassis of the mixer, preamp, or other device in your system.

Turning the Power On

Once everything is properly connected, be sure to follow the procedure below to turn on their power.

1. Rotate the [VOLUME] knob toward the left position to minimize the volume.

NOTE

Before turning the S9 on/off, always be sure to turn the volume down. Even with the volume turned down, you might hear some sound when switching the S9 on/off.

However, this is normal and does not indicate a malfunction.

2. Press the S9's [⏻] button located on the right panel to switch it on.

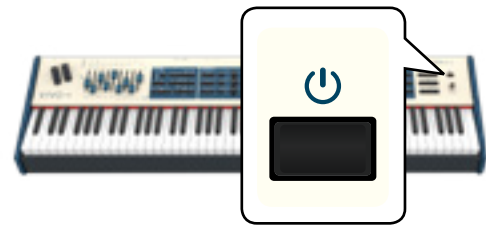

The power will turn on, a progress bar appear in the S9's display.



After a brief interval, the main page will appear. and S9 will be ready to produce sound.



3. Use the [VOLUME] knob to adjust the volume.

NOTE

This unit is equipped with a protection circuit. A brief interval (a few seconds) after power up is required before the unit will operate normally.

Turning the Power Off

1. Rotate the [VOLUME] knob toward the left position to minimize the volume.

NOTE

To avoid malfunctions, never disconnect the AC/DC adapter while the instrument is turned on.

2. Press the S9's [⏻] switch.

A power off confirmation message appears:

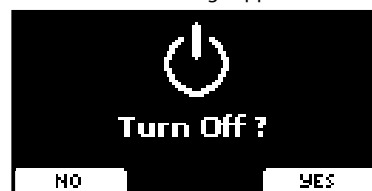

3. Press the "YES" Function button to confirm.

The display shows the following message:



and the unit will turn off after few seconds.

If you do not want power off press the "NO" Function button.

NOTE

If you need to turn off the power completely, first turn off the

instrument, then unplug the power cord from the power outlet. Refer to "Connecting the AC Adaptor" (p. 17).

If you do not operate the unit for a certain period of time while the power is on, this unit turns off automatically.

If you don't want the power to turn off automatically, turn the "AUTO OFF" setting off!

With the factory settings, the unit's power will automatically be switched off 120 minutes after you stop playing or operating the unit.

Shortly before the S9 shuts down automatically, the display starts counting down the seconds. If you want to keep using the S9 at this stage, press any button.

If you don't want the power to turn off automatically, change the "AUTO OFF" setting to "OFF" as described on p. 70.

Demo of the S9

Your S9 contains a demo that introduces all the best of its tones.

1. To start playback of all demo songs simultaneously press the [▶/||] and [SONG] buttons.

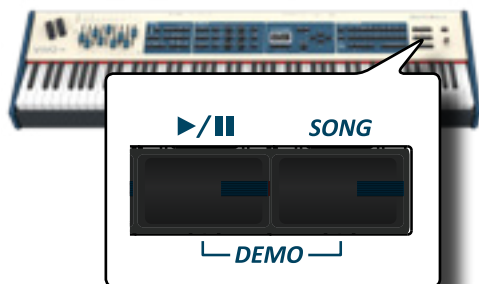

Playback starts automatically with the demo song.

2. Press the [MENU/EXIT] button to leave the demo function.

NOTE

No data for the music that is played back will be output from MIDI OUT.

NOTE

All rights reserved. Unauthorized use of this material for purposes other than private, personal enjoyment is a violation of applicable laws.

7 Basic Operation

About the Display and Cursor Operation

This section introduces the information that appear on the main page. Moreover this section illustrates how to navigate the menu.

Main Page

The main page contains many useful information.

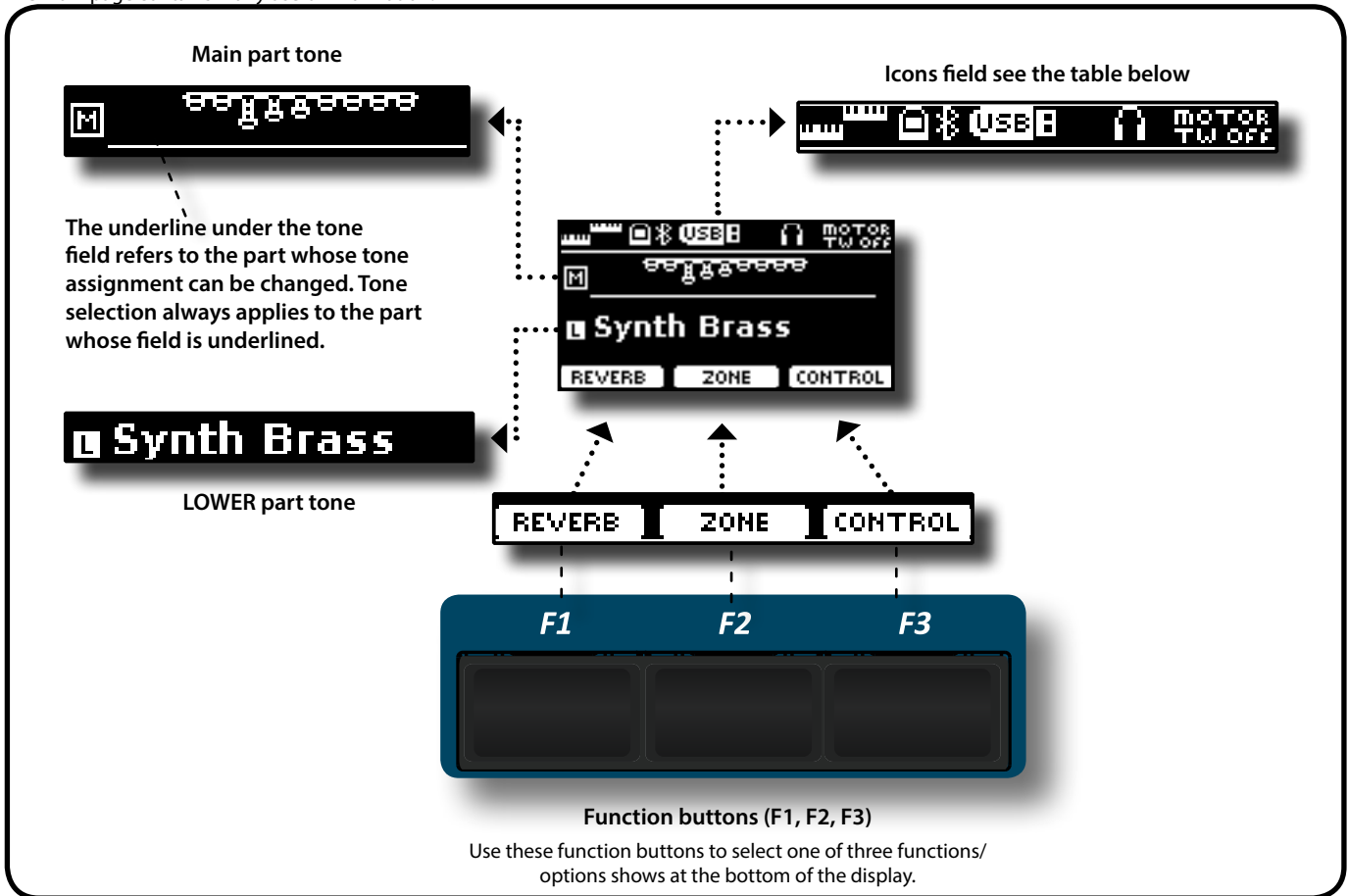

Example of main window with all keyboard parts active.

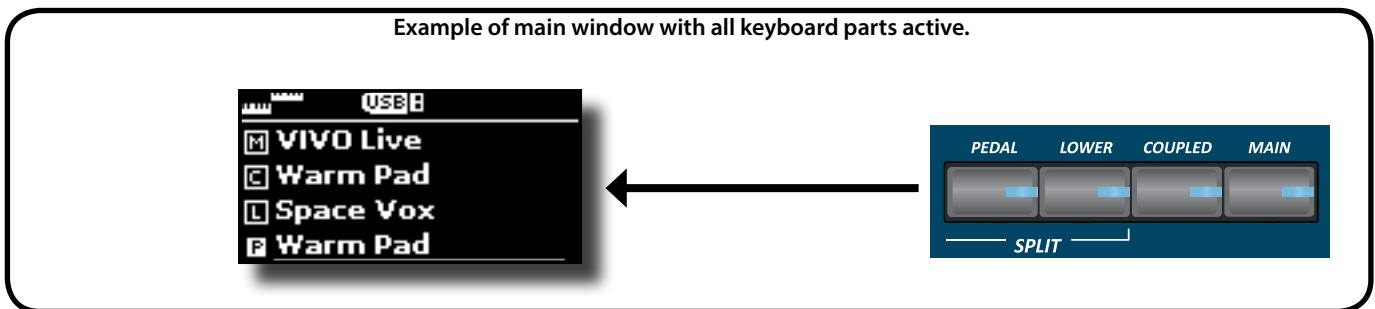

| Icons Field | Explanation | Icons Field | Explanation |
|-------------|--|-------------|---|
| | Keyboard Mode: | | Bluetooth indicator • Steady icon: Connected to a device. |
| | • No SPLIT | | A USB memory is connected to your unit. |
| | • SPLITTED (PEDAL or/and LOWER) | | An headphone is plugged into the PHONES output jack. |
| | A computer is connected to the S9's USB "COMPUTER" port. | | The "Motor Slider" parameter is set to "Off". See "Motor Slider" (p. 70). |

Moving the Cursor and Setting Parameter Values

1. Press the [MENU/EXIT] button to access to the available function groups.

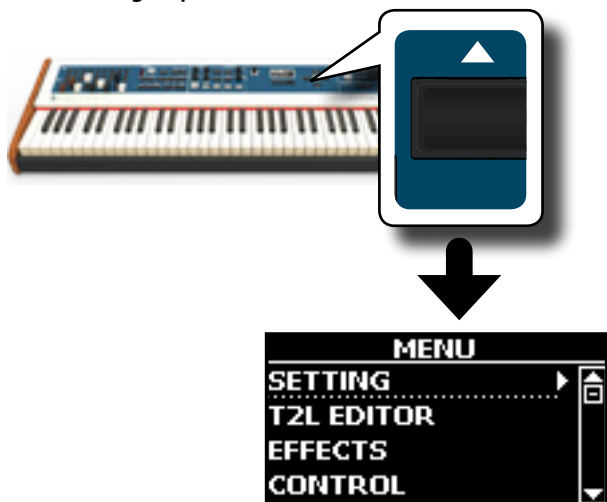

2. Use the [DATA ENTRY] knob or the [▲][▼] buttons to select the entry of the desired function group.

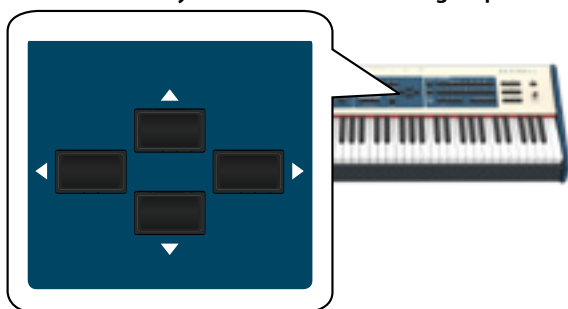

3. Press the [▶] button to enter in the selected function group.



4. Use the [DATA ENTRY] knob or the [▲][▼] buttons to scroll the list of settings and press the [▶] button to enter in the selected setting.
5. Use the [▲][▼] buttons to scroll the list of parameters. The selected parameter field is displayed in reverse
6. Use the [DATA ENTRY] knob or the [◀][▶] buttons to set the desired value.



7. Press the [MENU/EXIT] button to return to the main page.

Assigning the Name You Specify

In many cases you'll have to assign a name to a file. In the following example, we will learn how to give a Memory name.

After the selection of saving a Memory, the display looks as follows:



A Memory name is suggested by the S9.

1. Use the [DATA ENTRY] knob or the [▲][▼] buttons to select a different character.
2. Use the [◀][▶] buttons to select the next character position you want to change, then select the new character using the [DATA ENTRY] knob or the [▲][▼] buttons.
3. You can press the [A/a/#] F2 Function button to switch between Main- and lower-case characters as well as numbers.

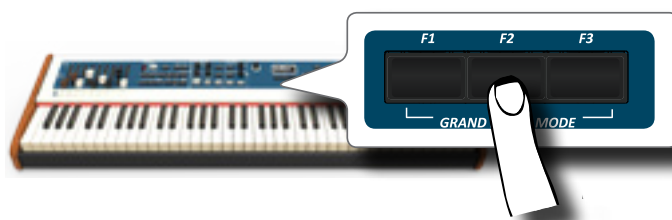

4. To delete the selected character, simultaneously press the F2 and F3 Function button.

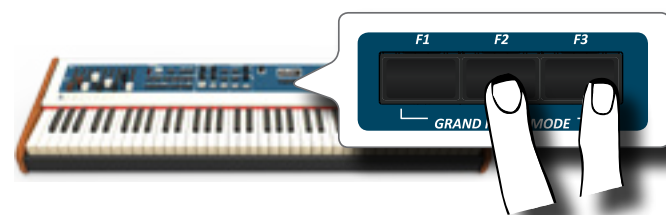

5. To insert a character, simultaneously press the F1 and F2 Function button.

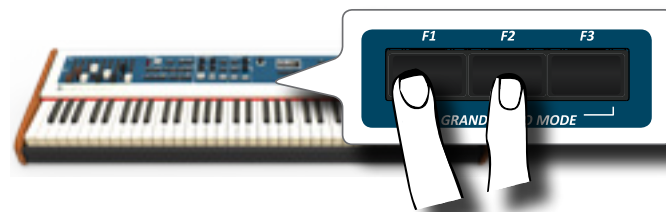

8 Selecting Tones

S9 has a wide selection of high quality tones arranged in nine categories. The S9 allows you to assign any of the available tones to any of the four real-time parts. Tone selection always applies to the part (Main, Coupled, Lower or Pedal) whose field is currently underlined in the main page.

The tone is selected and the window highlight you the name of the tone. After few seconds of inactivity of the change tone operation, the Main page is shown.

See page 75 for a list of available Tones.

How to Select Tones

If you want to select the [TW/ORGAN] sounds, please refer to the "Organ Section" (p. 28).

1. If the [SOUND] button is not already lit, press it to enable the nine family and number buttons to select tones.



The [SOUND] button lit.

2. Press the desiderate Family Tone button to select the sound category that you want to play.

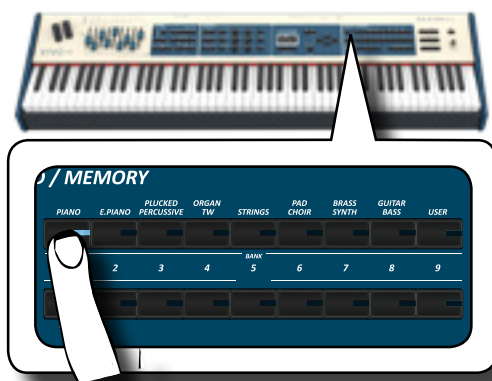

The last sound you selected for that category is recalled.

The button indicator lights and a temporary window shows the list of tones where the recalled sound is underlined:

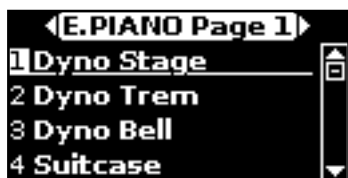

In the example was pressed [E. PIANO] button.

MEMO

While the tone window is active, use the [DATA ENTRY] knob or the [▲] [▼] buttons to select a tone in the same category. If during normal operation the window closes automatically, press the tone family buttons again.

3. Press the desiderate [1 ~ 9] Tone button to select a tone in the same category.

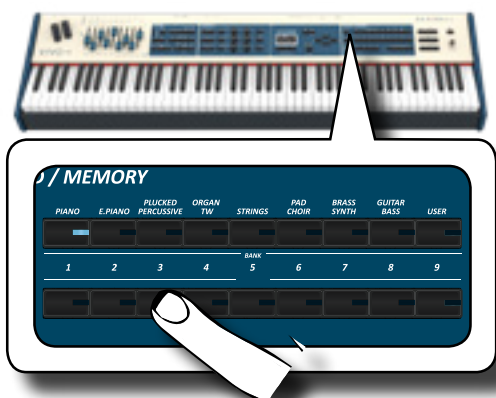

4. Play the keyboard.

You'll hear the sound of the selected instrument.

MEMO

The last sound you select in each category is memorized temporarily and will be recalled every time you press the corresponding Family Tone button

MEMO

While the tone window is active, press the [◀] [▶] buttons to select the previous or next tone category. After few seconds of inactivity of the change tone operation, the Main page is shown.

TIPS

A quick way to change a tone from the Main page: use the [◀] [▶] buttons to select a next or previous tone in the same category.

Most Frequently Used Tones (Favorite Tone)

The "Favorite Tone" function lets you an easy recall of most frequently used sounds. You can memorize a Favorite Tone for each of nine categories and recall it simply pressing the tone button. It will be helpful in a live performance situation.

1. Select a tone you prefer. See "How to Select Tones" (p. 24).
2. Press and hold the Family Tone button that contains the selected tone to memorize it.

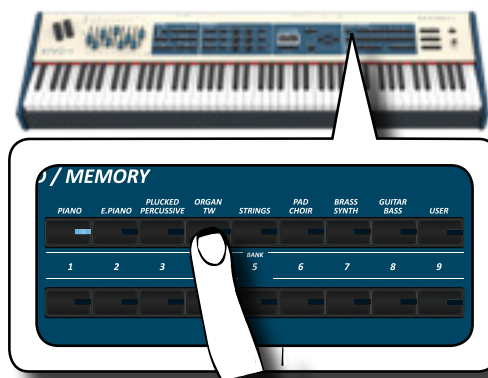

The display shows a confirmation message.

The position of the sound you selected is memorized and will be recalled every time you press the corresponding Tone button.

The instrument will remember your choice at the next power on.

NOTE

This function is not available for the "TW/ORGAN" family tone.

Playing Two Sounds Over the Entire keyboard (Layer)

In the previous paragraph "How to Select Tones", you learned how to select a Tone. Below you'll learn how to add a second sound over the entire keyboard.

1. Press the [COUPLED] button to add a second tone (Coupled Part) over the entire keyboard.

Splitting the Keyboard Range and Playing Two Different Tones (LOWER)

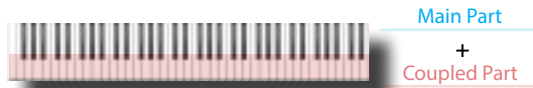

The Coupled part [C] is automatically selected.
If the main page is displayed shows:



The Coupled part [C] field in the main page is underlined to inform you that the tone selection is applied on this part.

NOTE

For Tone selection, it would be a good idea to check on the main page which part is currently selected to ensure that you don't select a Tone for the wrong part.

NOTE

Note that you cannot select a tonewheel preset for the Coupled part. This is because the Coupled part is not a typical organ part. The organs have only three keyboard parts: Main, Lower and Pedal.

2. Play the keyboard.

You'll hear the tones of Main part [M] and Coupled part [C] playing together.

3. To adjust the overall volume use the VOLUME knob.

4. To adjust the volume for the Main and Coupled keyboard see "Adjust the Volume and Reverb for Each Part by the Draw Faders" (p. 26).

5. To change a tone of the Coupled part, see "How to Select Tones" (p. 24).

6. To select the Main part, from the main page, use the [DATA ENTRY] knob or the [▲] [▼] buttons to select it.

7. To change a tone of the Main part, see "How to Select Tones" (p. 24).

Splitting the Keyboard Range and Playing Two Different Tones (LOWER)

Split mode enables you to play two different voices on the keyboard, one with the left hand (LOWER) and another with the right hand (MAIN).

1. If you want to use your left and right hands to play different Tones, press the [LOWER] button.



The Keyboard is divided into two sections. The region of the keyboard to the left of the split point becomes the LOWER part while the region of the keyboard to the right of the split point becomes the MAIN part.

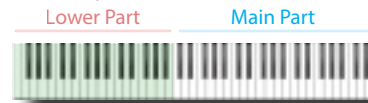

If the main page is displayed shows:



The Lower part [L] field in the main page is underlined to inform you that the tone selection is applied on this part.

2. Play the keyboard.

Turn the VOLUME slider to adjust the volume.

NOTE

Setting the "SPLIT" parameter in "OFF" you can play the Lower part in layer mode with the Main and Coupled parts.. See "Play All Parts in Layer Mode" (p. 26).

MEMO

The default split point is set between keys F3 and F#3. To change the split point see "How to change the Split Point" (p. 26).

3. To adjust the volume for the Main and Lower keyboard part see "Adjust the Volume and Reverb for Each Part by the Draw Faders" (p. 26).

4. To change a tone of the Lower part, see "How to Select Tones" (p. 24).

5. To select the Main part, from the main page, use the [DATA ENTRY] knob or the [▲] [▼] buttons.

6. To change a tone of the Main part, see "How to Select Tones" (p. 24).

Adding the PEDAL Part

The Pedal part can be played via the keyboard, or with an commercially available MIDI pedalboard.

1. Press the [PEDAL] button to add the pedal part on the keyboard. Its indicator lights.



The Keyboard is divided into two halves. The region of the keyboard to the left of the split point becomes the Pedal part, while the region of the keyboard to the right of the split point becomes the Main part.

If the Lower part is active, the pedal part is monophonic and the leftmost note played on the keyboard is added. In all other cases the Pedal part is polyphonic.

2. To change a tone of the PEDAL part, see "How to Select

Tones" (p. 24).

3. Play the keyboard.

Turn the VOLUME knob to adjust the volume.

MEMO

The default split point is set between keys F3 and F#3. To change the split point see "How to change the Split Point" (p. 26).

4. To adjust the volume for the Main and Pedal keyboard part see "Adjust the Volume and Reverb for Each Part by the Draw Faders" (p. 26).

Special Pedalboard Tones: "Pedal Bass" and "Pedal DoublBs".

In the sounds set of the S9 there are two special sounds that came in handy when you play bass note in rapid succession like jazz. The "Pedal Bass" and "Pedal DoublBs" sounds was sampled with a little bit sustain. In this way, lengthening the release of the sound, allows the organist to play the "walking" bass line.

Play All Parts in Layer Mode

The S9 give you the possibility to play the Lower and Pedal in layer with the Main and the Coupled part. To do this you need to set a parameter in off, this parameter is called "Split"

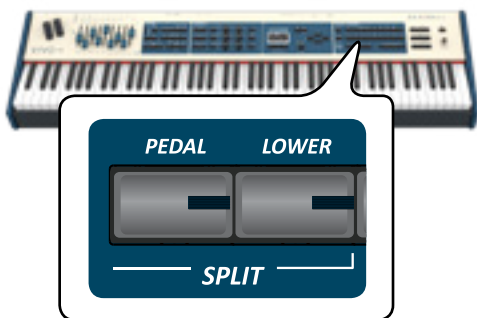

1. Press and hold the [LOWER] or the [PEDAL] button until the display shown the following page.



- 2. Use the [▲] [▼] buttons to select the "Split" parameter.**
- 3. Use the [DATA ENTRY] knob or the [◀] [▶] buttons to set the "Split" parameter to OFF.**

| Parameter | Setting |
|-----------|------------------------|
| Split | OFF, ON Default: ON |

Now all parts will play in layer.

MEMO

To play the keyboard in split mode set again the "SPLIT" parameter to "ON".

How to change the Split Point

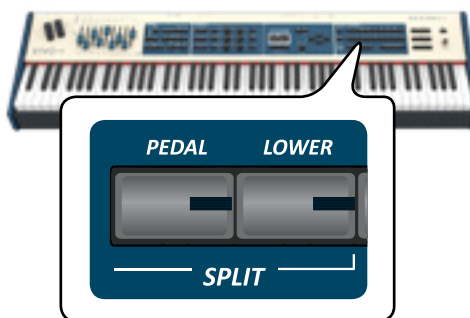

1. Press and hold the [LOWER] or the [PEDAL] button until the display shown the following page.



- 2. Use the [▲] [▼] buttons to select the "Split Point" parameter.**
- 3. Use the [DATA ENTRY] knob or the [◀] [▶] buttons to change the split point value.**

| Parameter | Setting |
|-------------|------------------------|
| Split Point | F1 ~ E7 Default: F3 |

MEMO

The "Split Point" parameter works when the keyboard is in split mode (Lower or Pedal part is selected) and the "Split" parameter is set to "ON" (default).

Adjust the Volume and Reverb for Each Part by the Draw Faders

By the draw faders you can adjust the volume for each part.



- 1. Press [MIXER] button to assign the 9 draw faders to adjust the volume or/and reverb for each part.**
- 2. You can adjust the volume for each part moving the corresponding draw faders. On the panel, below each one of draw fader, is indicated the assigned part.**
- 3. You can adjust the reverb for each part moving the corresponding draw faders. On the panel, below each one of draw fader, is indicated the assigned part.**

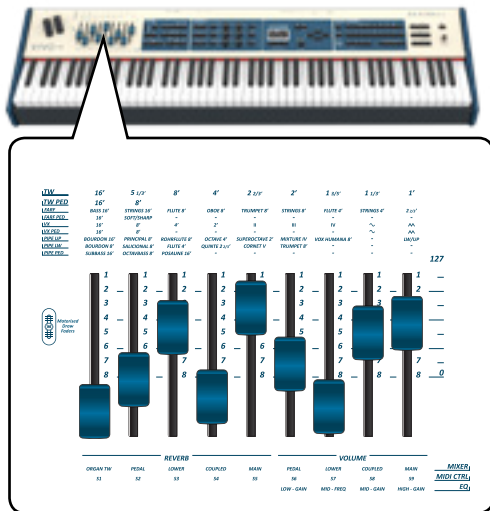

Tone MIDI Information

Tones can also be selected via MIDI. To this effect, they use an “internal” address, which is not usually displayed. For MIDI applications involving sequencers or external controllers, knowing the “official” address may come in handy. The S9 has an handy system that provides this information instantly—there is thus no need to look up the MIDI address in the tones list at the end of this manual.

1. Select a tone. See "How to Select Tones" (p. 24).

The following temporary page is showed:



In the example above we selected "VIVO Live" tone.

2. Press one of the Function buttons located below the display

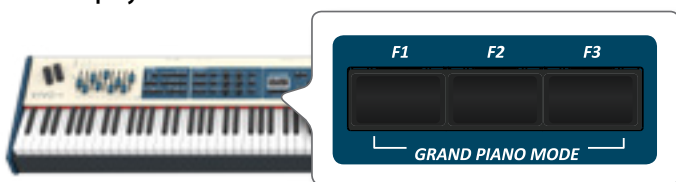

The tone MIDI information are temporary showed:



9 Organ Section

The S9 has a section that simulates famous electric organs. By sliding the nine motorised draw-faders in and out you can create a wide variety of tonalities. You can add various typical effects of an electric organ as a Leslie speaker.

Selecting Various Organ Types

The S9 comes with various organ models that reproduce the tonal characteristics of both tonewheel and transistor types organ: TW1, TW2, FARF, VX and PIPE. Moreover you have two user organ memory location (USER 1, USER 2) that allows you to expand the tonal resources of the instrument. You can download this selection of sounds from the www.dexibell.com website. See "How To Load Sound Libraries in a USB Memory" (p. 38).

The modification of the sound within the Organ section is primarily done through the use of Draw-faders. You can recall various position setting of them by the selection of bank and number buttons in the SOUND/MEMORY section.

1. Repeatedly press the [ORGAN TYPE] button until the indicator of the desired selection lights.

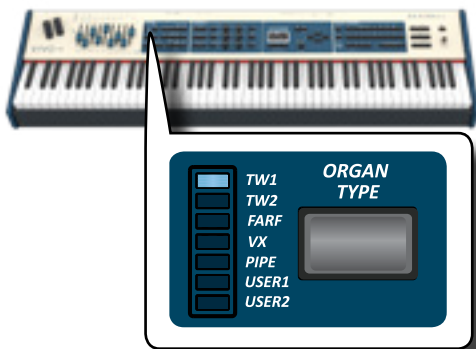

| Organ Type | Explanation |
|------------|--|
| TW1 | It's a simulation of a organ style cabinet that use an tonewheel apparatus for generating electric musical note. |
| TW2 | It's a simulation of an "home organ" style cabinet with some built-in speakers" that use a tonewheel apparatus for generating electric musical note. |
| FARF | This is a simulation of a portable transistors-based organ. |
| VX | This is a simulation of transistor-based combo organ. |
| PIPE | This simulate a pipe organ. It's a musical instrument that produces sound by driving pressurized air through organ pipes. |
| USER1 | You can download sounds from the www.dexibell.com website. See "Sound Library" (p. 37). |
| USER2 | |

The organ type selection is now available.

2. See "Selecting Presetted Organ Sounds" (p. 28) to select a tonewheel for that organ type.

Selecting Presetted Organ Sounds

1. Select the organ model you desired. See "Selecting Various Organ Types" (p. 28).
2. If the [SOUND] button is not already lit, press it to enable the nine family and number buttons to select tones.



The [SOUND] button lit.

3. Press the [TW ORGAN] button to select the tonewheel organ family.

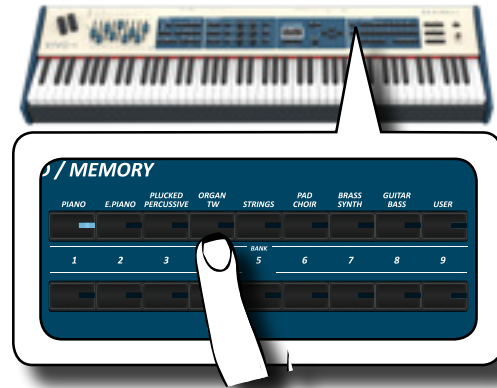

The last sound you selected for the organ category is recalled and the draw-faders move to reach the new footage value.

The button indicator lights and a temporary window shows the list of draw-faders where the recalled combination is underlined:



"Manual" indicate the current position of draw-faders.

The other items of the list indicate the most used combinations. Each number is the indication of the single draw-faders position value For example, the "00 5320 000" corresponds to the following position of draw-faders:

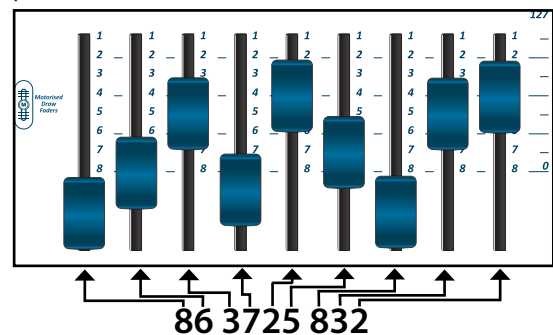

MEMO

While the tone window is active, use the [▲] [▼] buttons to select a tone in the same category. If during normal operation the window closes automatically, press the tone family buttons again.

4. Press the desiderate [1 ~ 9] button to select the sound in the same category.

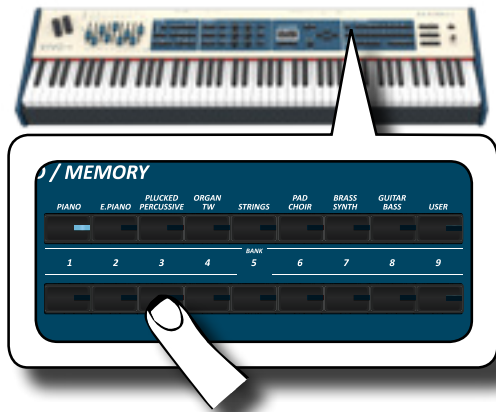

The tonewheel is selected and the window highlight the configuration of the draw-faders. The draw-faders move to reach the new footages position.

After few seconds of inactivity of the change tone operation, the Main page is shown. The main page shows the current position of each draw-faders and the footage indication.

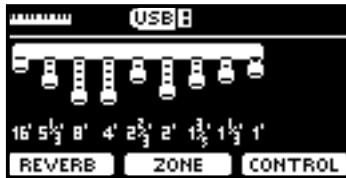

On the instrument panel, under or above each draw-fader, the feet used for each type of organ are listed.

5. Play the keyboard to enjoy the organ sound.
6. Use the draw-faders to change in real time the volume of each footage (See "Altering the Sound using Draw-faders" (p. 29)) or select another tonewheel.

Motorised Draw-faders

The draw-faders are the heart and soul of the sound of your organ. You can change the variety of sound through the manipulation of draw-faders.

The S9 has a powerful section of draw-faders. The motorized draw-faders are always in the right position ready for immediate use in real time. This solve the common problem in every Organ Keyboard: the draw-fader position that does not change after a preset/memory call.

Altering the Sound using Draw-faders

There are nine motorised draw-faders, each of them is coupled with one footage.

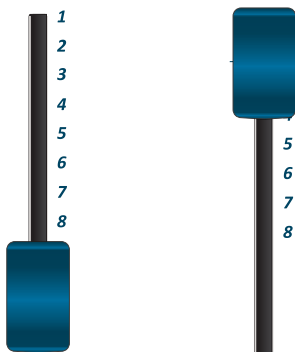

FULL VOLUME

NO VOLUME

1. Move a draw-fader down to increase the volume in incremental steps from 0 (no sound) to 8 (maximum

volume).

2. Move the draw-fader up to decreases the volume of that footage.

The main page shows the current position of each draw-faders and the footage indication.



Assigning the Draw-faders (TW ASSIGN)

You can select organ sounds for the MAIN, LOWER and PEDAL keyboard parts. It's evident that only one part at a time can be assigned to the draw-faders section.

There are three buttons (MAIN, LOWER and PEDAL) that allow you to specify which keyboard part is assigned to the draw-faders section.

1. Press [MAIN], [LOWER] or [PEDAL] bottom to assigned the keyboard part to the draw-faders section.

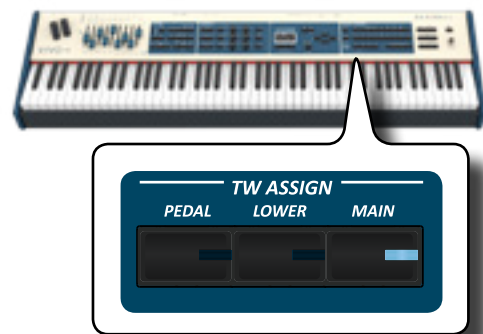

Useful Draw-faders Movement Functions (Morphing)

By this button you can manage some useful functions related to the movement of the draw-faders.



Morphing

This function acts on the automatic movement of draw faders. There are two modes of operation:

- **AUTO** - When you recall a preset of tonewheel, the position of the draw-faders is not achieved immediately, but within a specific time.
- **PEDAL** - The transition between two different combinations of draw-faders (FROM, TO) is performed by the movement of the expression pedal connected to the "ASSIGN 3 (MORPHING)" socket. See "Connecting the Pedals" (p. 17).

Activating Morphing Function

1. Press the [MORPHING] button to activate the function. Its indicator lights.

Selecting the AUTO Mode

1. Press and hold the [MORPHING] button until the MORPHING page appears:



2. Set the "Auto" mode. See "Moving the Cursor and Setting Parameter Values" (p. 23).
3. Select the time value you want for the movement of the draw faders: Slow, Medium and Fast.

Selecting the PEDAL Mode

1. Press and hold the [MORPHING] button.
2. Set the "PEDAL" mode. See "Moving the Cursor and Setting Parameter Values" (p. 23).

The display changes as follow:



Now you can set the following parameters:

| Parameter | Value | Steps |
|-----------|----------------------|---|
| Part | Main, Lower, Pedal | 3. Select the keyboard part on which the function act. |
| From | Draw faders position | Starting position of draw faders. 4. Select the "From" parameter and move the draw faders to set the desired "From" position. |
| To | Draw faders position | Destination position of draw faders 5. Select the "To" parameter and move the draw faders to set the desired "To" position. |

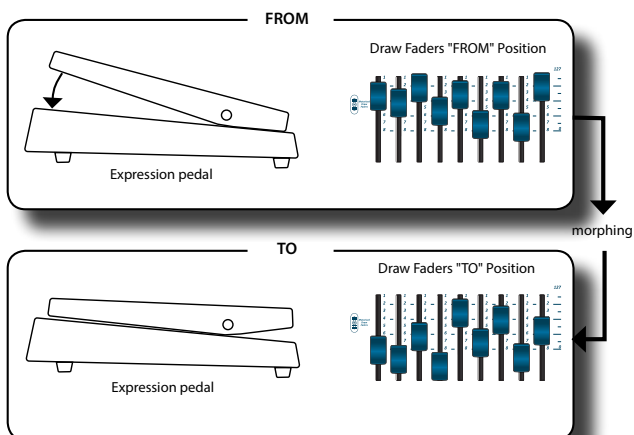

6. Moving the expression pedal from up to down, the draw faders will move gradually from the "FROM" to the "TO" combination.

MEMO

The morphing's settings can be saved in the memories. See "Working with the Memories" (p. 47).

Applying Vibrato/Chorus Effect

The S9 has a vibrato effect and a chorus effect to enrich your performances. The vibrato and chorus system consists of six settings, V1, V2, V3, C1, C2 and C3 (i.e., 3 vibrato and 3 chorus), which can be selected via the [TYPE] button.



1. Press the [ON] button to activate the effect. Its indicator lights.
2. Press the [TYPE] button to open the VIBRATO/CHORUS page and change effect.
3. Use the [DATA ENTRY] knob or the [◀] [▶] buttons to set the desired effect and depth.
4. You can press also the [TYPE] button to select the next effect.

| Setting | Explanation |
|-----------------|---|
| V1,C1 | Vibrato or Chorus light depth effect |
| V2, C2 | Vibrato or Chorus standard depth effect |
| V3,C3 | Vibrato or Chorus deepest effect |
| TREMULANT 1 ~ 6 | It's a characteristic effect of the pipe organ that produces a fluctuation of the amplitude and pitch of the sound, producing a tremolo and vibrato effect. NOTE This effect can be selected in the presence of an pipe organ sound. |

Adding Overdrive Effect

This is the typical effect of vacuum tube amplifier and it is achieved by "overdriving" the valves.



1. Press the [OVERDRIVE] button to add overdrive effect. Its indicator lights.

The display shows the overdrive value.

2. Use the [DATA ENTRY] knob or the [◀] [▶] buttons to set the desired value.

| Parameter | Setting |
|-----------|---------|
| DRIVE | 1~100 |

Editing Overdrive Parameter

1. Press the [OVERDRIVE] button to open the "OVERDRIVE" page.
2. Press the "EDIT" F3 function button to access the "OVERDRIVE EDIT" page.
3. You can adjust the following parameter:

| Parameter | Setting | Explanation |
|--------------|--------------|--|
| Drive | 1~100 | Adjust the amount of effect. Also changes the volume. |
| Tone | 1~100 | Adjusts the tonal quality of the sound. |
| Level | 1~100 | Use this parameter to compensate for exaggerated level differences resulting from the settings you made. |
| Eq Low freq | 80 ~ 400 Hz | Selects the frequency of the low range. |
| Eq Low gain | -12dB~0~12dB | Gain of the low frequency range. |
| Eq High freq | 800Hz ~ 8KHz | Selects the frequency of the high range. |
| Eq High gain | -12dB~0~12dB | Gain of the high frequency range. |

4. Press the [MENU/EXIT] button to come back to main page.

Adding Harmonic Percussion

It's the classic crisp attack unique to the vintage organ. This effect was designed to emulate the percussive sounds of the harp, xylophone and marimba. When the percussion is selected, this feature adds a decaying second- or third-harmonic overtone when a key is pressed.

NOTE

The harmonic percussion feature is available for the TW1 and TW2 organ type and only on the MAIN or LOWER keyboard part.

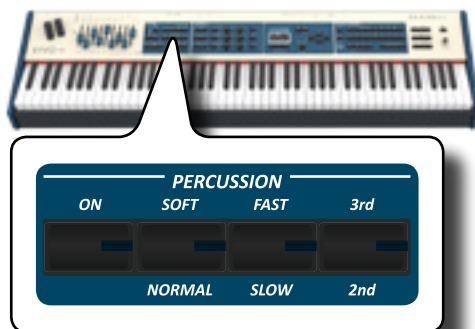

1. Press the [ON] button to add the percussion to the sound. Its indicator lights.
2. Press the [SOFT/NORMAL] button to select between a soft (the indicator lights) or hard percussion levels.
3. Press the [FAST/SLOW] button to select between a fast

(the indicator lights) or slow decay.

4. Press the [3rd/2nd] button to select between the third (the indicator lights) or second harmonics.

Adding Rotary Effect

By this section you turn it on or off the Rotary effect. This effect simulates the typical sound modulation generated by a cabinet with rotating loudspeakers.

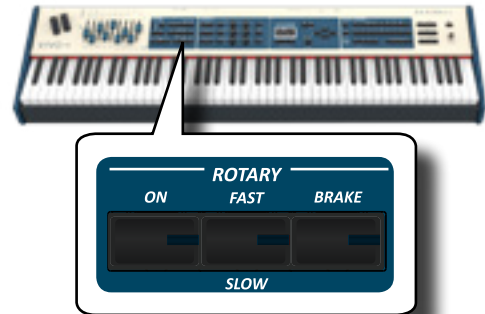

1. Press the [ON] button to add the rotary effect. Its indicator lights.
2. Press the [FAST/SLOW] button to select between the fast (the indicator lights) or slow speed.
3. Press the [BRAKE] button to stop the rotation of the rotary. When this is turned on (button's indicator lit), the rotation will gradually stop. When it is turned off, the rotation will gradually resume.

10 Adding Effects to Orchestral Sound

NOTE

This effects section is not available for the Tonewheel sounds.

Going Around Sound Effects

The S9 is quite simply a superlative instrument with the most advanced and best sound generation technology Dexibell has to offer.

The S9 is equipped with two units of effectors (FX-A and FX-B) for each keyboard part (Main, Lower, Coupled and Pedal).

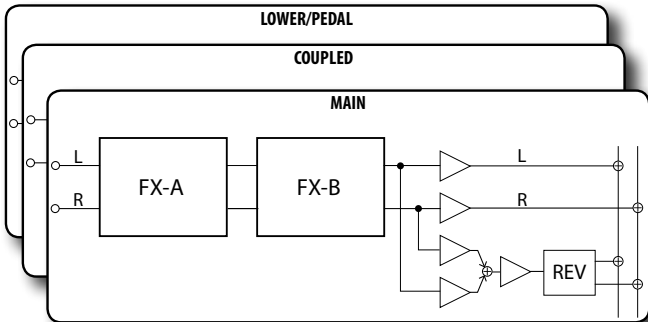

When you recall a Tone the instrument automatically add the appropriate effects for that sound.

FX Real-time Controls

The S9's panel is equipped with real-time knobs to adjust the effector parameters during your live performance.

Two of the relevant parameters of the current effects are automatically assigned to the knobs: C1, C2 for the Main part, C3, C4 for the Coupled part and C5, C6 for the Lower/Pedal part.

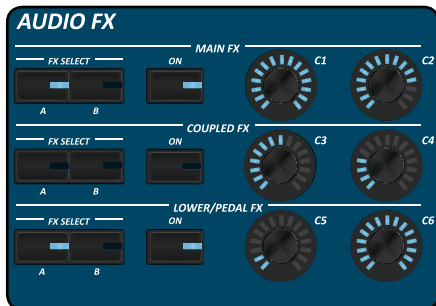

1. Press the [FX SELECT] button of the relative part to select which effector (A or B) you want to assign to the knobs.
2. Turn the relative C1~C6 knob to adjust the amount of the assigned effect.

The display shows a temporary page with the current values and other important informations.

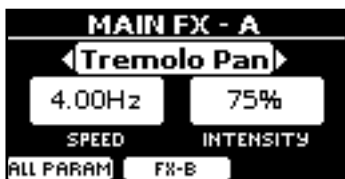

In the example above we rotated the C1 knob of the Main part. If the current sound is a tonewheel, the S9 reminds you that this section is only available for orchestral sounds.



3. Press the [ON] button if you want bypass the effect. It's indicator light off

Selecting a Sound Effect to the Part

1. Select: [MENU] button → EFFECTS. See "Moving the cursor and setting parameter values" (p. 16).

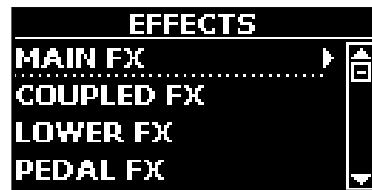

2. Use the [DATA ENTRY] knob and the button [▶] to select the part and access the related parameters.



In the example above we selected the "Main Fx".

MEMO

Instead of [DATA ENTRY] knob, You can also use the [▲] [▼] buttons to scroll the items

3. Use the [DATA ENTRY] knob to choose the Type of effect. For the list of effects see "Effects Types and Parameters List" (p. 44).
4. Use the [▲] [▼] buttons to select the parameter relative to the chosen effect.
5. Use the [DATA ENTRY] knob to adjust the parameter value. For details about the parameters for each effects, see p. "Effects Types and Parameters List" (p. 44).
6. To edit the second FX processor, press the "FX-B" F2 Function button.

Adding Reverb to the Sound

The reverb enables you to select various digital reverb effects that would add extra depth and expression to the sound to create a realistic acoustic ambience. You can adjust the reverb value for each part.

1. While the main page is displayed, press the F1 Function button to access the Reverb parameters.

Adjust the Reverb for Each Part by the Draw Faders



The display shows the Reverb page:



As you can see, you have an additional part, the **ORGAN** part. The ORGAN part is the part of the tonewheel. For example, if you selected a tonewheel in the Main part, to adjust the reverb you have to change the value of the ORGAN part and not the Main part.

MEMO

You can also select this function pressing [MENU] button → EFFECTS → REVERB.

- Use the [▲] [▼] buttons to specify the part you wish to change the Reverb level.
- Use the DATA ENTRY knob or the [◀] [▶] buttons to adjust the Reverb level.
- Using the F1 Function button you can enable or disable the Reverb for all parts of the keyboard.



Changing the Reverb Type

This parameter allows you to specify what kind of reverb effect you need.



- While the Reverb page is displayed, press the "TYPE" F2 Function button to access the Reverb Type page.



- Use the DATA ENTRY knob or the [◀] [▶] buttons to choose the Macro Type you prefer.

The available Macro reverb types are:

Setting

Hall, Dark Hall, Mid Hall, Concert Hall, Large Hall, Chathedral, Arena, Cave, Chamber, Room, Venue, Ambience, Wooden Room, Brick Room, Studio Booth, Small Room, Living Room, Office, Warehouse, Music Club, Plate, Small Spring, Bright Spring, AmpSpring

Adjust the Reverb for Each Part by the Draw Faders

By the draw faders you can adjust the reverb for each part.



- Press [MIXER] button to assign the 9 draw faders to adjust the reverb for each part.
- You can adjust the reverb for each part moving the corresponding draw faders. On the panel, below each one of draw fader, is indicated the assigned part.

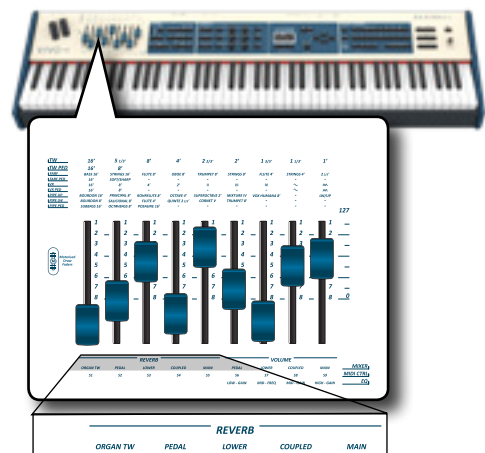

11 Other Functions

Transposing the pitch of the keyboard

The Transpose setting allows the pitch of your digital piano keyboard to be raised or lowered in semi-tone steps.

This is particularly useful when accompanying instruments tuned for different keys, or when a song learned in one key must be played in another key or when a singer sing in a key different than the original music.

1. Press the [TRANPOSE] button.



The display shown the following page.



2. Use the DATA ENTRY knob or the [◀] [▶] buttons to adjust the transposition value.

"Transpose" setting

-12 ~ 0 ~ +12 (semitone units)

If you set a value different than 0, the [TRANPOSE] button indicator lights and the keyboard is transposed.

3. Press the F1 Function button to enable or disable the transposition.

MEMO

You can also select this parameter pressing [MENU] button SETTING → TRANPOSE.

Shifting the Tuning of a Keyboard Part in Octave Steps

The Octave function is an useful parameter that allows you to change the pitch of the selected part in octave steps (12 semitones at a time).

1. Press the [OCTAVE] button.



The following page appears:



The display shown the octave value for each part.

2. Use the the [▲] [▼] buttons to select the keyboard part you want to change the octave.
3. Use the [DATA ENTRY] knob or the [◀] [▶] buttons to set the desiderate octave for the selected part.

Aftertouch

The S9 is equipped with an Aftertouch-sensitive keyboard.

Aftertouch is generated when you press a key even further down after playing a note. The aftertouch will affect to all notes playing in that keyboard part. The effect obtained is usually a filter.

1. Press the [AFTERTOUCH] button to enable the function. Its indicator lights.



Assigning a function

1. Press and hold the [AFTERTOUCH] button to open the "AFTERTOUCH" page.



2. Use the [▲] [▼] buttons to select the "Funct." (Function) parameter.
3. Use the [DATA ENTRY] knob or the [◀] [▶] buttons to set the desiderate function.

4. By the "Main", "Coupled", "Lower" and "Pedal" parameters you can choose on which part works the aftertouch.

See below the list of controls you can assign:

| Control | Explanation |
|------------|--|
| Aftertouch | You can control the aftertouch. |
| Modulation | You can control the modulation by the aftertouch. |
| FX Manual | You can control the FX manual of the effector by the aftertouch, see "16: Wah-Wah" (p. 74) and "17: Cut Filter" (p. 74). |

Performing Musical Chords

S9 is equipped with two chord features: Chord Enhancer and Chord Freeze.

Chord Enhancer

This function improve the sound plays automatic harmonies that are added to the chord that you are playing using the Main and/or Lower part. The Chord Enhancer function works when a tone of the Strings, Choir, Brass or Pad family is selected and the function is active (CHORD [ENHANCER] button indicator is lit). To know which tones you can use, see the "S9 Orchestral Tones List" (p. 75).

1. For example, select a tone of the String, Choir or Pad family on the Main part. See "How to Select Tones" (p. 24).

Same behavior if at the point (1) you selected a tone for the Lower part.

2. Press the CHORD [ENHANCER] button.



The [ENHANCER] button indicator lights and the Chord Enhancer function is active.

NOTE

If the current selected tone is not a tone of the Strings, Choir, Brass or Pad family, the Enhancer function is disabled.

3. Play a chord on the keyboard.
The Chord Enhancer function adds notes to the chord you played.
4. Press the CHORD [ENHANCER] button to leave this function.

Chord Freeze

If you need to play the same complex chord and play it quickly in different tonality on the keyboard, this is your function.

The Chord Freeze allows you to memorize a complex chord and play it in different tonality on the keyboard using a finger only.

MEMO

The Chord Freeze function is only available for the Main and Coupled keyboard parts.

1. Playing and holding the chord (at least two notes) on the keyboard that you want "Freeze", press the CHORD [FREEZE] button.



The chord is memorized and the CHORD [FREEZE] indicator lights.

2. Play a note on the keyboard with the desired tonality.
The chord previously memorized is reproduced with the same tonality of the played note.
You can now on until the function is active play the chord using one

finger.

3. If you need to memorize another chord:
 - a. Press the CHORD [FREEZE] button to leave the function.
 - b. Playing and holding the new chord, press the CHORD [FREEZE] button.
The chord is now memorized and you can play it as before.
4. Press the CHORD [FREEZE] button to leave this function.
5. If during your performance you need to use the same chord, you don't need to memorize it again. Without pressing any keys on the keyboard, press the CHORD [FREEZE] button to enable the function.

Adjusting the Keyboard Response (Key Touch)

This parameter is only for the orchestral sounds. As you know, the organ sounds have fixed dynamics.

If you selected an orchestral sounds and the keyboard response don't meet your taste, you can adjust it. You can choose until to five dynamic response.

1. Press [MENU/EXIT] button and select SETTING→KEYBOARD TOUCH function. See "Moving the Cursor and Setting Parameter Values" (p. 23).
2. Use the [DATA ENTRY] knob or the [◀] [▶] buttons to choose your desiderate dynamic response.

The following settings are available:

| Setting | Value | Explanation | | |
|----------------|--|--|-------|---|
| Keyboard Touch | Light++, Light+, Light, Normal, Heavy, Heavy+, Heavy++, Fixed [1~127] | "Heavy" range: Select this setting for maximum expressiveness. Even small variations of the force with which you strike a key produce audible changes. The trade-off is, however, that you have to strike the keys forcefully to reach the maximum volume. | | |
| | | "Normal": Medium velocity sensitivity. The keyboard responds to velocity changes, but the maximum volume can be obtained more easily than with "Hard". | | |
| | | "Light" range: Select this settings if you do not want velocity changes to bring about major volume changes. | | |
| | | "Fixed": Select this setting if all notes you play on the keyboard should have the same velocity value. When you set this parameter, the "Fixed value" field can be edited. | | |
| | | *Fixed Value | 1~127 | Allows you to set the value when "Curve" is set to "Fixed". |

[*] This parameter can only be edited if the "Keyboard Touch" parameter is set to "Fixed".

Customize the Global Keyboard Response (Key Touch)

We have previously seen how you can choose the keyboard response from 7 predefined curves: Heavy ++, Heavy+, Heavy, Normal, Light, Light+, Light++. Here below we will see how to modify the velocity curve as you wish, starting from one of the preset curves.

1. Press [MENU/EXIT] button and select SETTING→KEYBOARD TOUCH function. See "Moving the Cursor and Setting Parameter Values" (p. 23).

The following page is shown.



2. Use the [DATA ENTRY] knob or the [◀] [▶] buttons to choose your desiderate dynamic response.
3. To customize the velocity curve press the F1 Function button.
4. Use the [◀] [▶] buttons to select one of the 5 points that characterize the curve: "pp", "p", "mf", "f", "ff".
5. Use the [▲] [▼] buttons to modify the value of the selected point.

| Curve Point | Explanation |
|-------------|---|
| | "pp" standing for <i>pianissimo</i> and meaning "very soft". |
| | "p" standing for <i>piano</i> and meaning "soft". |
| | "mf" standing for <i>mezzo-forte</i> and meaning "half loud". |
| | "f" standing for <i>forte</i> and meaning "loud". |
| | "ff" standing for <i>fortissimo</i> and meaning "very loud". |

6. Use the "RESET" Function button to restore the point at the default value.
Your velocity curve is automatically saved in the global area when the instrument is turned off.

Adjusting the AUDIO IN Input Level

The input level of the audio source you connect can be set with the "AUDIO INPUT Level" parameter.

1. Press [MENU/EXIT] button and select SETTING→AUDIO INPUT function using the [▲], [▼] and [▶] buttons. See "Moving the Cursor and Setting Parameter Values" (p. 23).



2. Use the [DATA ENTRY] knob or the [◀] [▶] buttons to adjust your desiderate the AUDIO IN level.

Restoring the Factory Settings (Factory Reset)

The following function allows you to recall the S9's original factory settings.

WARNING

All data will be deleted. Backup your own settings to an USB memory.

1. Press [MENU/EXIT] button and select FACTORY RESET function. See "Moving the Cursor and Setting Parameter Values" (p. 23).

The display shows the following window.

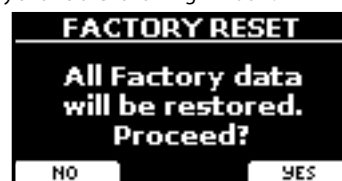

2. Press the "YES" Function button proceed.

The message "Complete" informs you that the S9 has been initialized.

NOTE

The Factory Reset function doesn't initialize the Global Area.

Restore the Factory Sounds

Using this function you can restore all sound libraries as they came out of the factory.

1. Press [MENU/EXIT] button and select FACTORY SOUND function. See "Moving the Cursor and Setting Parameter Values" (p. 23).

The following page appears:

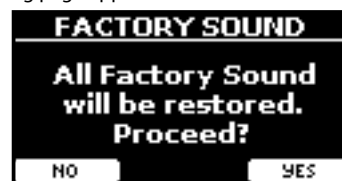

2. Press the "YES" Function button proceed.

The message "Complete" informs you that the S9 Sound Libraries has been restored.

If you no longer want to restore the sound libraries, press the "NO" Function button

12 Sound Library

What is a Sound Library?

The sound (patch) in the DEXIBELL's devices is composed of several oscillators that reproduce waveforms. The patch contains also information about Pitch,/TVA,/TVF envelope, filters and so on. All this and more contributes to shapes the sound.

A Sound library contains sounds that use the same waveforms. For example, the "Electric Piano" library, contains the following sounds: Dyno Stage, Suitcase, Phaser EP, etc.

Sound Library Memory Structure

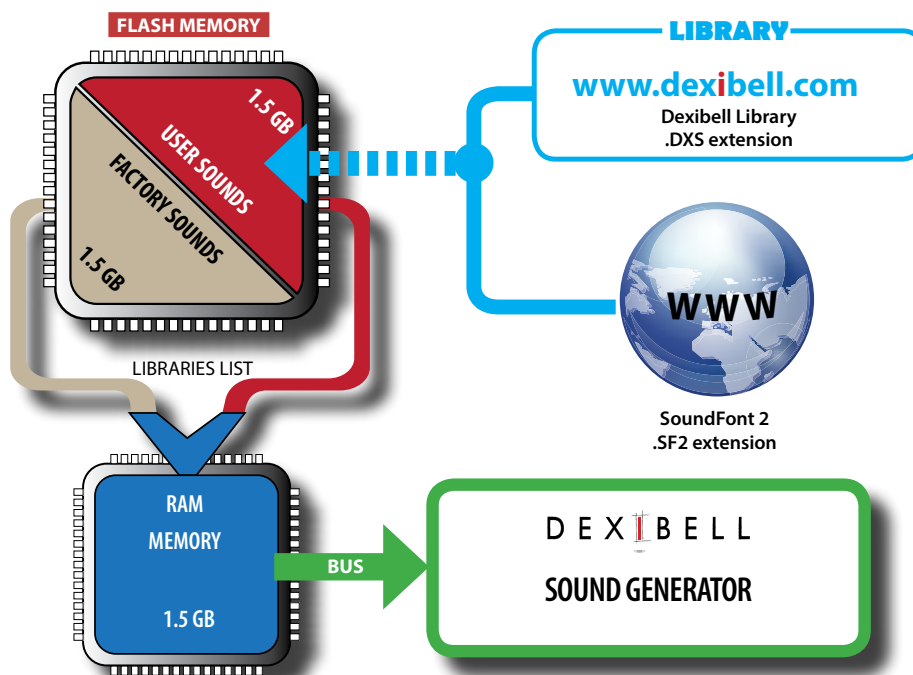

The S9's Internal Flash Memory contains the Sound Libraries. This memory is divided into two parts of 1.5 GB:

- the first part, not erasable, contains the Factory Libraries.
- the second part, programmable, can contain the User Sound Libraries.

Using the list of libraries to load, at the power on, the S9 load the sound libraries from the Internal Flash Memory into the Internal RAM of 1.5 GB. At default, the list contains the Factory Libraries only.

You can load the new libraries into the User Sound area by taking them from the DEXIBELL library (www.dexibell.com) or from third-party sounds (.SF2 extension).

By a programmable list you can choose which sound libraries (User or Factory or part of them) to load in the RAM Internal Memory. You can decide to completely replace the factory sounds loading all sound from the User sounds area or decide to load a part of the sounds from the factory area and another from the User area.

Sound Library

S9 gives you the possibility to install new sounds from:

- DEXIBELL Official Sounds (.DXS extension)

These sounds will be available and downloadable from the following website:

<http://www.dexibell.com/>

Stay tuned for new sounds and updates by visiting our website regularly!

- third-party sounds (.SF2 extension)

You can easy found in the web many sounds library with .SF2 extension. S9 is compatible with these types of sounds.

Factory area ("INTERNAL ARCHIVE") ready to be reloaded again. See "Recovery a Library from the "INTERNAL ARCHIVE"" (p. 39) and "Restore the Factory Sounds" (p. 36).

1. Press the [SOUND LIBRARY] button to open the "SOUND LIBRARY" page.



A page like this appears:





The list of the Sound Libraries in the internal Memory are showed. You can note, at the left of each library name, a icons:

Remove and Add Sound Libraries

In the "SOUND LIBRARY" page you can decide which libraries load into the RAM area.

NOTE

The removed libraries are not deleted. They remain in the

| Icon | Explanation |
|---|---|
|  | The library sound comes from the Factory Sound libraries. |
|  | The library sound comes from the User Sound libraries. |

At the bottom of the screen you can recall two functions: "REMOVE" and "ADD". Here below, we will explain how to remove or add sound libraries.

Removing a Sound Library



1. Use the [DATA ENTRY] knob or the [▲] [▼] buttons to select the sound library you want to temporary remove.
2. If you want to know the sounds contained in the library, press the [▶] button to open it.



3. If you want to listen the sounds of the library, use the [▲] [▼] buttons to select the sound and activate notes by the keyboard of the S9.
If you don't need of these sounds, you can proceed with the removal.
4. From the "SOUND LIBRARY" page, press the "REMOVE" F1 Function button to perform the removal.

The display shows:



5. Press the "YES" Function button to perform the removal.
Press "NO" if you no longer want to perform the function.

NOTE ABOUT THE REMOVAL OF SOUND LIBRARIES

- **Factory libraries** - The factory libraries are not deleted but are removed from the list of libraries to load at startup.
- **User Sound libraries** . The User Sound libraries are permanently deleted. Make sure to have a backup, if you think you need them again.

How To Load Sound Libraries in a USB Memory

You can import sounds library in the User Sound memory of S9 and use them in your performances. To import them you need an USB Memory and your Personal computer.

Loading a sounds library in a USB Memory

1. Using your computer, download the new sound library from the DEXIBELL web site (.DXS) or from any other web site (.SF2).
2. Create a folder "SOUND" in the root of the USB Memory.
3. Copy the sound library (.DXS/.SF2) into the USB Memory's "/SOUND" folder.
4. Insert the USB Memory into the S9 USB port. See "Connecting an USB Memory (commercially available)" (p. 19).
5. See "Adding a Library from USB Memory" (p. 38) to import the sound library.

Adding a Library



1. Press the "ADD" F2 Function button to add a library.

The display shows the libraries previous removed:



In the example above, the list of removed libraries is empty (no libraries has been previously deleted). In this case you can add only libraries from an USB Memory previously loaded.

The following example shows that some libraries was removed and the list of "INTERNAL ARCHIVE" shows which they are:



2. If you want get information about the RAM Internal free memory, press the "FREE SIZE" F1 Function button.



The page shows the RAM Internal memory available express in MB and percent.

This function is useful to know how much available free memory you have to load new libraries.

Adding a Library from USB Memory

1. To load the library into your USB Memory, please refer to "Loading a sounds library in a USB Memory" (p. 38).

- Insert the USB Memory into the USB port of the S9.
- From the "INTERNAL ARCHIVE" page, press the "USB" Function button to list the sound libraries in the USB Memory.

The following page is showed:



The instrument shows the sound libraries contained in the USB Memory's "SOUND" folder.

MEMO

To navigate inside the folders use the [▶] button to open a folder and the [◀] button to return to a higher level.

Press the "INTERNAL" Function button to return to viewing the internal archive.

- Use the [DATA ENTRY] knob or the [▼] [▲] buttons to select the sound library you prefer.
- To open the sound library, press the [▶] button.

The sound/sounds contained in the library are displayed.



- Use the [DATA ENTRY] knob or the [▼] [▲] buttons to select the sounds and listen them by the keyboard. If the sounds are to your liking, you can import the library into the internal memory.
- if you want to know the size of the library, press the "INFO" F2 Function button.



- Press the "IMPORT ALL" Function button to import the sound library. The instrument asks you in which sound family you want to import the library:



- Use the [DATA ENTRY] knob or the [◀] [▶] buttons to select in which sound family you want to import the library.
- Press the "EXECUTE" F1 Function button to perform the function.

A confirmation message informs you that the sound library has been imported.

Recovery a Library from the "INTERNAL ARCHIVE"

Thanks to this function you can reload previously removed internal libraries.



- Use the [DATA ENTRY] knob or the [▼] [▲] buttons to select the library you want reload into internal memory.

- To open the sound library, press the [▶] button.

The sound/sounds contained in the library are displayed.



- Use the [DATA ENTRY] knob or the [▼] [▲] buttons to select the sounds and listen them by the keyboard.

If the sound is to your liking, you can import the library into the internal memory.

- if you want to know the size of the library, press the "INFO" F2 Function button.



- Press the "IMPORT ALL" F1 Function button to import the sound library.

The instrument asks you in which sound family you want to import the library:



- Use the [DATA ENTRY] knob or the [◀] [▶] buttons to select in which sound family you want to import the library.

- Press the "EXECUTE" F1 Function button to perform the function.

A confirmation message informs you that the sound library has been imported.

How to Restore the Factory Sound

See "Restore the Factory Sounds" (p. 36).

How to Select USER Sounds

The S9 has two memory areas.

The first area, divided in USER1 and USER2, is selectable from the [ORGAN TYPE] button.

The second area is selectable from the [USER] button in the orchestral sounds selection panel.

To select a User sound, please see "Selecting Various Organ Types" (p. 28).

How to Select USER Organ Sounds

Before to select a USER sound, you need to import sounds. Please see "How To Load Sound Libraries in a USB Memory" (p. 38).

1. Repeatedly press the [ORGAN TYPE] button until the indicator select the USER1 or USER 2 type organ.

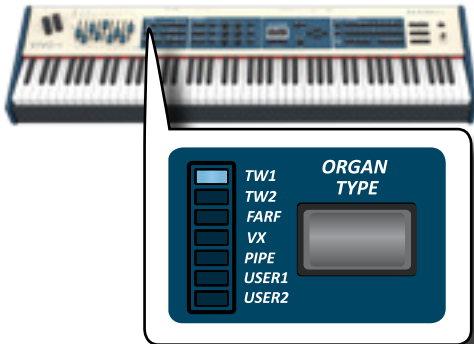

2. If a Tonewheel is not already selected, you need to select one of them. If the [SOUND] button is not already lit, press it to enable the nine family and number buttons to select tones.



3. Press the [TW ORGAN] button to select the tonewheel organ family.

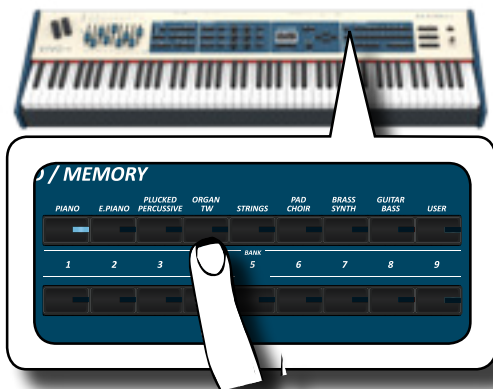

The display shows the list of the tonewheel preset.

4. Press the [desiderate [1 ~ 9] Sound button to select the User preset.

How to Select USER Orchestral Sounds

Before to select a USER sound, you need to import sounds. Please see "How To Load Sound Libraries in a USB Memory" (p. 38)..

1. If the [SOUND] button is not already lit, press it to enable the nine family and number buttons to select tones.



2. Press the "USER" button.

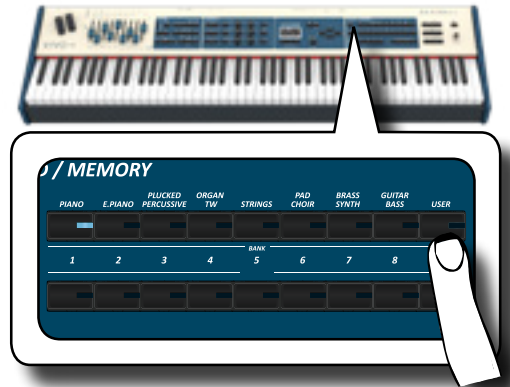

The last sound you selected s recalled.

The button indicator lights and a temporary window shows the list of User tones where the recalled sound is underlined:



3. Press the desiderate [1 ~ 9] Sound button to select a User sound.

The User sound is selected and the window highlight you the name of the sound. After few seconds of inactivity of the change sound operation, the Main page is shown.

4. The User sounds are arranged in pages of 9 sounds. While the sound window is active, press the [◀] [▶] buttons to select the previous or next tone User page. After few seconds of inactivity of the change tone operation, the Main page is shown.

TIPS

A quick way to change a tone from the Main page: use the [◀] [▶] buttons to select a next or previous sound in the same category.

13 Sound Setup (Export/Import)

This is a useful function that allows you to prepare a sound set for a performance. If, in a performance, you will use only piano sounds, you can create a Sound Set that contain only piano sounds. In this way you can use the maximum size of internal memory of the module for piano sounds.

At your convenience, you can also download sound sets from the <http://www.dexibell.com/> website.

Exporting a Sound Set ("EXPORT SETUP")

This function export the sound set, that you have previously prepared, in a USB Memory.

1. Prepare your Sound Set using the functions previously explained: "ADD" and "REMOVE". See "Remove and Add Sound Libraries" (p. 37).
2. Insert a USB Memory into the USB port of your instrument.
3. Press the [MENU/EXIT] button and use the [DATA ENTRY] knob or the [▼][▲] buttons to select the "SOUND SETUP" function group.



The "SOUND SET" page appears:



4. Use the [DATA ENTRY] knob or the [▼][▲] buttons to select "EXPORT SETUP" and press the [▶] button to access the function.

The display changes to:



5. If you want to name your Sound Set, please see "Assigning the Name You Specify" (p. 23).

6. Press the "OK" Function button to save your Set.

A confirmation message is temporarily showed.

Importing a Sound Set ("IMPORT SETUP")

This function import the sound set previously saved in a USB Memory.

NOTE

Before to import a Sound Set take in consideration that your current Sound Set, in the internal memory, will be replace.

You can lost external sound libraries previously loaded from a USB Memory. Regarding the internal sound libraries no problem, You can recover them in the "INTERNAL ARCHIVE". See "Adding a Library" (p. 38).

1. Insert a USB Memory that contains previously saved Sound Set into the USB port of your instrument.
2. Press the [MENU/EXIT] button and use the [DATA ENTRY] knob or the [▼][▲] buttons to select the "SOUND SETUP" function group.



The "SOUND SET" page appears:



3. Use the [DATA ENTRY] knob or the [▼][▲] buttons to select "IMPORT SETUP" and press the [▶] button to access the function.

The display shows the list of the Sound Set in the USB Memory:

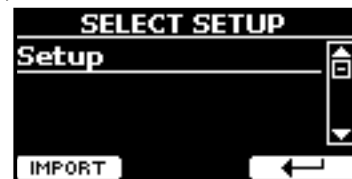

4. Use the [DATA ENTRY] knob or the [▼][▲] buttons to select the Sound Set.
5. Press the "IMPORT" F1 Function button to load the Sound Set.

A confirmation message is temporarily showed.

14 Personalizing Your Sounds (T2L)

T2L-Modelling



The revolutionary technology found on all models of DEXIBELL keyboards. T2L-Modelling is the combination of innovative technologies developed to achieve maximum timbre accuracy and precise sound responsiveness.

T2L modelling has many algorithms that simulate all the characteristics of an acoustic piano. It take care of many aspect as:

No Damper ("No Damper" on high notes)

The last 18 higher notes, like in the acoustic instrument, do not have the presence of the dampers and then are free to vibrate even when keys are released.

The duration of these notes, playing in staccato mode, is much longer than the previous notes that instead have the presence of the damper.

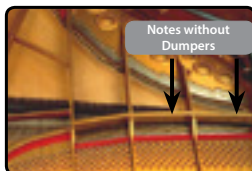

FP-Simulation ("DAMPER Pedal" multi actions simulation)

The "DAMPER" Pedal (Sustain), performs several actions that are simulated through this function.

- A) When the "DAMPER" pedal is pressed, a sound is generated to simulate the damper friction noises of felts when releasing from the strings (Damper Friction Noise).
- B) Pressing the "DAMPER" pedal, the active notes will be enriched with resonances produced by all strings free to vibrate, thanks to the raised dampers (Strings Resonance). The result of the Strings Resonance makes the sound of a sustained note by the use of the "DAMPER" pedal substantially different from the sound of a just held note.
- C) When the "DAMPER" pedal is released, a noise is simulated like the mechanical noise in the acoustic instrument (Sustain Pedal Mechanical Noise).

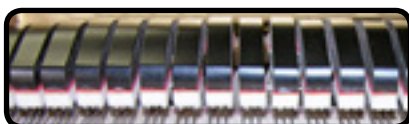

(A) & (B) "DAMPER" pedal is pressed, felt dampers are raised.

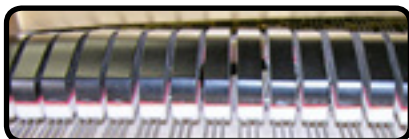

(C) "DAMPER" pedal is released, felt dampers are resting on strings.

See "DAMPER PEDAL" (p. 40).

SP-Simulation ("Soft Pedal" Simulation)

The "Soft" Pedal, acts a change of volume and timbre color of the sound, simulating the "soft" function on the acoustic piano.



Soft Pedal

You can change many sound parameters at will.

Making Slight Additions or Sound Alterations

Although Dexibell sound are developed to achieve the maximum sound accuracy, you can necessity to modify them at your taste them or create new sonority.

Take note that the parameters of the sound you want modify are of the part (Main, Coupled, Lower, Pedal). This means that the same sound modified for the Main part will sound different if selected from the Coupled part

1. Select the sound that you want personalize. See "How to Select USER Sounds" (p. 39).
2. Press the [T2L] button to access the Editor functions.

MEMO

You can also select this function pressing [MENU] button → T2L EDITOR.

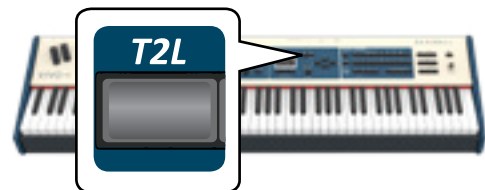

3. Use the [DATA ENTRY] knob or the [▲] [▼] buttons to select in which part you want modify the sound.

The display shows the Editor sound page that contains all possible parameters for the tone you selected:

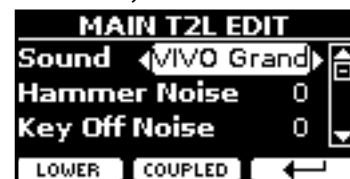

In the example above the VIVO Grand piano was selected.

4. Use the [▲] [▼] buttons to select the parameter you wish to modify.
5. Use the [DATA ENTRY] knob or the [◀] [▶] buttons to adjust the value.

Saving your changing

All you need to do is to save your setting in a memory. See "Working with the Memories" (p. 47).

Parameters to be edited

The parameter list depends on the characteristics of the selected sound.

Orchestral Sounds Parameters

Hammer-Noises (Key On impulsive Noises)



Attack of notes contains an impulsive portion of sound produced by the hit of the Hammer to the strings, amplified and sustained by the resonance of the piano body. A function is available to reduce/increment this element of the sound.

| Parameter | Setting |
|--------------|---------------|
| Hammer Noise | -64 ~ 0 ~ +63 |

Key Off Noise (Key Off Mechanical Noises)

The release of keys causes mechanical noises proportional to the speed of the release itself. This behavior of the acoustic instrument is reproduced by this function

| Parameter | Setting |
|---------------|---------------|
| Key Off Noise | -64 ~ 0 ~ +63 |

Damper Noise

This is the typical noise of an acoustic piano when the pedal sustain is pressed (lift all dampers) or released (lower all dampers).

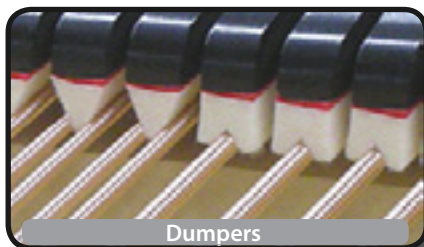

| Parameter | Setting |
|--------------|---------------|
| Damper Noise | -64 ~ 0 ~ +63 |

String Reso (Sympathetic Harmonic Resonances)

As in the acoustic Piano, while holding down some keys and playing other notes in staccato mode, a multitude of additional harmonics can be listened, thanks to "sympathetic resonance" generated by the free to vibrate strings (due to raised dampers) of the held notes.

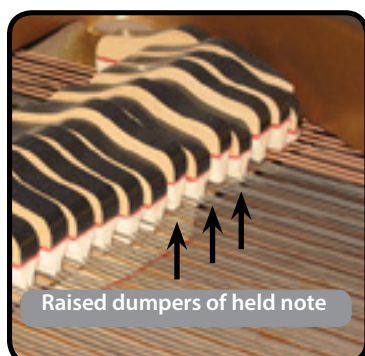

| Parameter | Setting |
|-------------|---------------|
| String Reso | -64 ~ 0 ~ +63 |

Damper Reso

It's the typical noise generated by the free to vibrate strings (all damper raised) when the damper pedal is pressed.

| Parameter | Setting |
|-------------|---------------|
| Damper Reso | -64 ~ 0 ~ +63 |

Cabinet Reso (for Wurly, Ac. Guitar, and Harp)

Thanks to this parameter you can increase or decrease the cabinet resonance.

| Parameter | Setting |
|--------------|---------------|
| Cabinet Reso | -64 ~ 0 ~ +63 |

Bell (for Electric Piano)

The "bell sound" is characteristic of some electric pianos that became particularly popular throughout the 1970s.

You can adjust the quantity of this typical sound.

| Parameter | Setting |
|-----------|---------------|
| Bell | -64 ~ 0 ~ +63 |

Click (for Vintage Organ)

The key click is typical of vintage organs. It's a electrical pop which was the result of the keys making contact. It was considered a defect, there were all kinds of efforts to reduce it, but it never could be eliminated. Meanwhile it has become a characteristic "click" for rock and modern musicians. You can adjust quantity of click sound when press and release a key.

| Parameter | Setting |
|-----------|---------------|
| Click | -64 ~ 0 ~ +63 |

Growl (for Electric Piano)

This is a typical distortion of the sound during the phase attack that give a "growling" effect. Thank to this parameter you can increase or decrease the effect.

| Parameter | Setting |
|-----------|---------------|
| Growl | -64 ~ 0 ~ +63 |

Off Noise (for Clavinet, Harpsy, Church Organ, E. Piano, Bass, Trumpet)

You can adjust the quantity of the noise effect that some instrument produce when the key is released.

| Parameter | Setting |
|-----------|---------------|
| Off Noise | -64 ~ 0 ~ +63 |

On Noise (for Trumpet, Flugelhorn)

This parameter adjust the quantity of the noise of the trumpet when the piston is pressed.

| Parameter | Setting |
|-----------|---------------|
| On Noise | -64 ~ 0 ~ +63 |

Attack, Hold, Decay, Sustain and Release (For Brass, Strings, Pad, Choir, Synth)

These parameters characterize the envelope of the sound. For example, when an organ key is pressed, it plays a note at constant volume; the sound dies quickly when the key is released. By contrast, the sound of a guitar is loudest immediately after a string is plucked, and quickly fades. Try to change the envelop of a sound by these parameters.

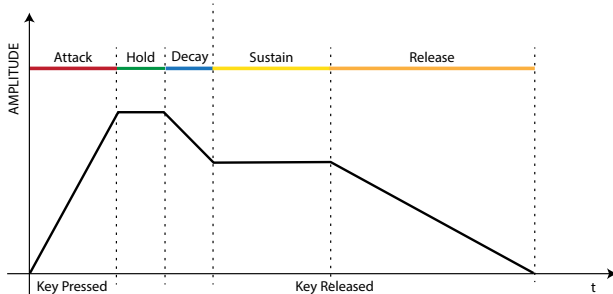

| Parameter | Setting |
|-----------|---------------|
| Attack | |
| Hold | |
| Decay | -64 ~ 0 ~ +63 |
| Sustain | |
| Release | |

Ride

This parameter increase or decrease the volume of Ride Cymbals sound contained in the "Ac. Bass&Ride" tone.

| Parameter | Setting |
|-----------|---------------|
| Ride | -64 ~ 0 ~ +63 |

Amp noise

This parameter simulates the noise of the bass amplifier.

| Parameter | Setting |
|-----------|---------------|
| Amp noise | -64 ~ 0 ~ +63 |

String noise

This parameter simulates the resonance of the bass strings.

| Parameter | Setting |
|--------------|---------------|
| String noise | -64 ~ 0 ~ +63 |

Key Noise

This parameter simulates the noise of Saxophone Key.

| Parameter | Setting |
|-----------|---------------|
| Key noise | -64 ~ 0 ~ +63 |

Polyphonic

This parameter becomes useful when you use some solo instruments like flute, violin, saxophone, trumpet and accordion.

| Parameter | Setting | Explanation |
|------------|-----------------------|--|
| Polyphonic | Low, High, Last, Poly | Low - The part becomes monophonic and play the leftmost note you played. High - The part becomes monophonic and play the rightmost note you played. Last - The part plays monophonic. Poly - The part plays polyphonic. |

Blow

Blowing is possibly the most important part of any woodwind instrument. This parameter adjusts the amount of blowing in a flute sound.

| Parameter | Setting |
|-----------|---------------|
| Blow | -64 ~ 0 ~ +63 |

Pluck

This parameter is used to emphasize the sounds of "Pedal Bass" e "Pedal DoubleBs". It works to emphasize the attack phase of the sound.

| Parameter | Setting |
|-----------|---------------|
| Pluck | -64 ~ 0 ~ +63 |

Tonewheel parameters

Volume

This parameter reduce the volume of the tonewheel. When you set the "Soft" value the volume of the tonewheel became slightly softer in volume and equalization.

| Parameter | Setting |
|-----------|--------------|
| Volume | Normal, Soft |

Leakage

In the vintage electro-mechanical organs, sometimes the signal from adjacent tonewheels causes pickups to overhear tonewheels other than their own. This noise, originally considered to be a defect, grew to be an integral part of the electro-mechanical organ sound. Use this parameter to modify the amount of leakage.

| Parameter | Setting |
|-----------|---------|
| Leakage | 0 ~ 127 |

Hum noise

The sound of the organ is produced by an electro-magnetic pick-up. So some hum is normal and unavoidable in an electro-mechanical organ. If you think you suffer from excessive hum, you can modify the level.

| Parameter | Setting |
|-----------|---------|
| Hum noise | 0 ~ 127 |

Click On Noise and Click Off Noise

Some electro-mechanical organs have an audible pop or click when a key is pressed or released. Originally, key click was considered a design defect and the designers worked to eliminate or at least reduce it with equalization filters. Over time has become a characteristic part of the sound and it has been accepted as part of the classic sound. Use this parameter to adjust the amount of click noise.

Adjusting the Keyboard Velocity Response According to the Sound

| Parameter | Setting |
|-----------------|---------|
| Click On Noise | 0 ~ 127 |
| Click Off Noise | |

Perc. Manual

It's the classic crisp attack unique to the vintage organ. See "Adding Harmonic Percussion" (p. 26). The percussion is a typical register in the Main manual. With this parameter, you can choose which part of the keyboard (MAIN or LOWER) to add the percussion effect.

| Parameter | Setting |
|--------------|-------------|
| Perc. Manual | Main, Lower |

Expression Min

The expression pedal is an important control for many musical instruments including organs. Use this parameter to set the minimum value of the expression when the pedal is lifted.

| Parameter | Setting |
|----------------|---------|
| Expression Min | 0 ~ 127 |

Express. Tone

When the volume falls, the sound of the high or low frequencies becomes difficult to hear. When this parameter is set to "On", when the volume falls, the low frequency are less attenuated than Mid/high frequencies.

| Parameter | Setting |
|---------------|---------|
| Express. Tone | Off, On |

Brilliance

This parameter is enabled when you select a Pipe organ type. You can adjust the brightness of sound.

| Parameter | Setting |
|------------|-----------|
| Brilliance | -12 ~ +12 |

Rotary Parameters

Rotary Block Diagram

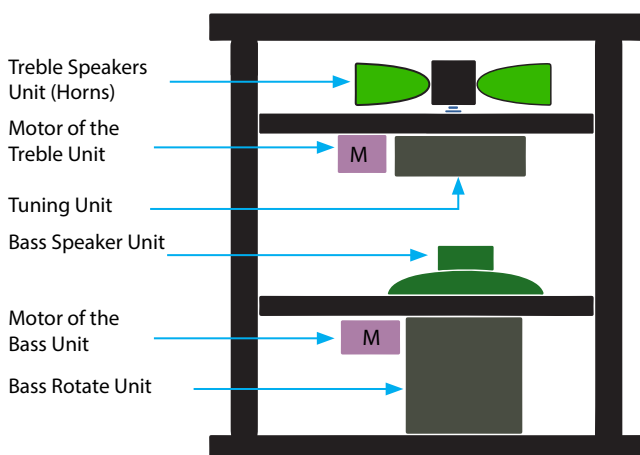

Rotary Noise

This is the noise when the motor is running. Use this parameter to adjust the amount of the noise.

| Parameter | Setting |
|--------------|---------|
| Rotary Noise | 0 ~ 127 |

Horn Slow RPM and Horn Fast RPM

These parameters adjust the speed of the horn rotor at the slow and fast mode.

| Parameter | Setting |
|---------------|-----------|
| Horn Slow RPM | 20 ~ 100 |
| Horn Fast RPM | 300 ~ 500 |

Horn RampUp and Horn RampDw

These parameters set the time for the horn rotors to "ramp up" and to "ramp down" when switching from slow to fast (Horn RampUp) or when switching from fast to slow (Horn RampDw).

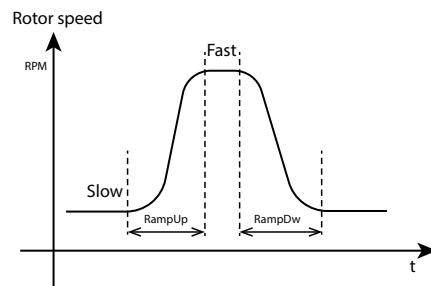

| Parameter | Setting |
|----------------|---------------|
| Horn RampUp | 0.2 ~ 15 sec. |
| Horn Ramp Down | |

Bass Slow RPM and Bass Fast RPM

These parameters adjust the speed of the bass rotor at the slow and fast mode.

| Parameter | Setting |
|---------------|-----------|
| Bass Slow RPM | 20 ~ 100 |
| Bass Fast RPM | 300 ~ 500 |

Bass RampUp and Bass RampDw

These parameters set the time for the bass rotors to "ramp up" and to "ramp down" when switching from slow to fast (Bass RampUp) or when switching from fast to slow (Bass RampDw).

| Parameter | Setting |
|-------------|---------------|
| Bass RampUp | 0.2 ~ 15 sec. |
| Bass RampDw | |

Adjusting the Keyboard Velocity Response According to the Sound

By the "Velocity Compand" function in the T2L MENU, you can adjust the keyboard velocity for each sound. You can choose to expand the velocity of a Piano sound and compress the velocity of a strings or Pad sound.

1. Please refer to the "Making Slight Additions or Sound Alterations" (p. 42) to access the "T2L EDITOR" functions. How to select the keyboard part and the sound to edit it.
2. In the example below we selected the sound of the Main part. Use the [DATA ENTRY] knob or the [▲] [▼] buttons

to move the cursor under the "Velocity Compad" function.



3. Press the button [▶] to access the function.

The following page appears:



4. Use the [▲] [▼] buttons to select one of the three parameters available.
5. Use the [◀] [▶] buttons to adjust the parameter you selected.

| Parameter | Setting | Explanation |
|-----------|---------|---|
| Start | 0~127 | It is the starting point of the velocity curve where you want to operate with the compression or expansion. |
| Rate | 0.1~8.0 | It is the compression/expansion coefficient that you want to use. |
| Offset | 0~127 | It's the minimum value of velocity. |

In the example below you can see that the Start point was set to 52, the "Offset" starts from the value 35 and the rate was set to 2.7.

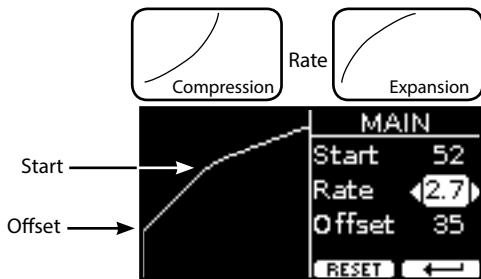

6. Press the "RESET" Function button to restore the parameters at the default value.

15 Working with the Memories

Using the Memories is a lot faster than calling up one of the S9's functions, modifying the settings, etc., while playing.

The instrument provides some Memories (81 memories) that allow you to store almost all settings (or registrations) you make on the front panel and the various display pages. Additional Memories can be imported directly from a USB Memory.

About the Memories and Memory Set structure.

The Memories you create are saved in the internal Memory Set or in an external Memory Set previously saved in the USB Memory. This allows you to prepare one set of Memories for weddings, another for corporate events, a third for anniversaries, etc.

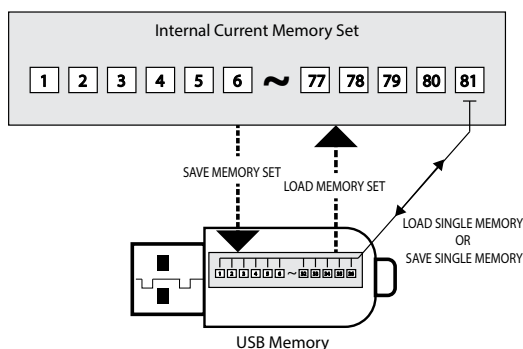

Saving Your Settings in the Internal Memory

1. Change all settings the way you want to save them.

For details on settings memorized, see p. 61.

2. Press and hold the [MEMORY/WRITE] button.

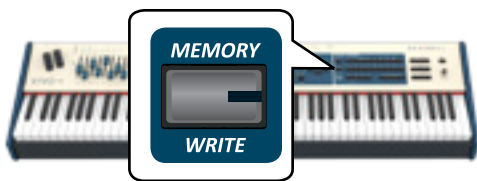

The display shows:

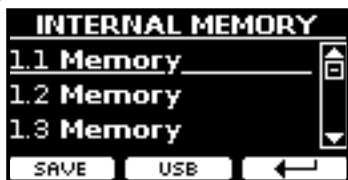

The [MEMORY/WRITE] button indicator lights and the list of Internal Memory is shown.

MEMO

You can also select this function pressing [MENU] button →MEMORY→WRITE.

3. Use the bank (Sound Families) and number buttons to select the position you want to replace the Memory. You can also use the [▲][▼] buttons to move the cursor inside the list to select the Memory you want to replace.
4. Press the "SAVE" Function button to confirm.

The display changes to:



5. If you want to name your new Memory, see "Assigning the Name You Specify" (p. 23) for details.

6. Press the "OK" Function button to save the Memory.

The memory will be saved and the list of Internal Memory is shown.



Recalling your Settings from Internal Memory

1. Press the [MEMORY/WRITE] button.

The [MEMORY/WRITE] button indicator lights steady and the list of Internal Memory is shown.



MEMO

You can also select this function pressing [MENU] button →MEMORY→RECALL.

2. Use the bank (Sound Families) and number buttons to recall the Memory you want.

You can also use the [DATA ENTRY] or the [▲][▼] buttons to move the cursor inside the list to select the Memory you want to recall and press the "RECALL" Function button.

The Memory is recalled and the display shows the Memory highlighted.



Saving Your Settings in the USB Memory (commercially available)

1. Connect the USB Memory to which you wish to save the Memory. See "Connecting an USB Memory (commercially available)" (p. 19).
2. Change all settings the way you want to save them.

- Press and hold the [MEMORY/WRITE] button until the display shows:



The list of Internal Memory is shown.

MEMO

You can also select this function pressing [MENU] button →MEMORY→WRITE.

- Press the [USB] Function button to select the destination memory.

The display shows a list of all files and folders on the USB storage device you have just connected.



Now you can save:

- In a Memory Set previously saved. Continue from step (5)
- In a new Memory Set. See "Saving in a New Memory Set" below.

Saving in a Memory Set previously saved

- Use the [DATA ENTRY] or the [▲][▼] buttons to scroll through files and folders to select the Memory Set.

| Memory Set Icon | Memory Set file extension |
|-----------------|---------------------------|
| | .rif |

Use the "OPEN" Function button if you need to enter in a folder. If you opened a folder by mistake, press the [←] button to return to a higher level.

- Press the "OPEN" Function button to recall the Memory Set.

The display shows the list of memories in the Memory Set.



- Use the bank (Sound Families) and number buttons to select the position you want to replace the Memory.

You can also use the [DATA ENTRY] or the [▲][▼] buttons to move the cursor inside the list to select the the Memory Set you want to save and press the "SAVE" Function button.

- Press the "SAVE" Function button to confirm.

The display changes to:



The name of the current memory is suggested.

- If you want to name your new Memory, see "Assigning the Name You Specify" (p. 23) for details.

- Press the "OK" Function button to save the Memory.

The memory will be saved and the list of memories is shown.



Saving in a New Memory Set

- Press the "NEW SET" Function button to create an empty Memory Set.

This page allows you to create a new Memory Set List whose name is selected automatically by the S9.



- If you want to name your new Memory Set, see "Assigning the Name You Specify" (p. 23) for details.

- Press the "OK" Function button to confirm the name.

The display shows contents of the new Set just created.



- Use the bank (Sound Families) and number buttons to select the position you want to write the Memory.

You can also use the [DATA ENTRY] or the [▲][▼] buttons to move the cursor inside the list to select the position of the memory you want to save and press the "SAVE" Function button.

- Press the "SAVE" Function to confirm.

The display changes to:



The name of the current memory is suggested.

- If you want to name your new Memory, see "Assigning the Name You Specify" (p. 23) for details.

7. Press the "OK" Function button to save the Memory.

The memory will be saved and the list of Memories is shown.



Recalling your settings from an USB Memory

1. Connect the USB Memory to which you wish to save the Memory. See "Connecting an USB Memory (commercially available)" (p. 19).

A USB icon appears in the Icons field of Main page. See "Main Page" (p. 22).

2. Press the [MEMORY/WRITE] button.

The [MEMORY/WRITE] button indicator lights steady and the list of Internal Memory is shown.



MEMO

You can also select this function pressing [MENU] button →MEMORY→RECALL.

3. Press the "USB" Function button.

The display shows a list of all files and folders on the USB storage device you have just connected.



4. Use the [▲][▼] buttons to scroll through files and folders to select the Memory Set.

| Memory Set Icon | Memory Set file extension |
|---|---------------------------|
|  | .rif |

Use the "OPEN" Function Button to enter in a folder.

If you opened a folder by mistake, press the [↶] button to return to a higher level.

5. Press the "OPEN" Function button to open the selected Memory Set.

The display shows the list of Memories:



6. Use the bank (Sound Families) and number buttons to recall the Memory you want.

You can also use the [DATA ENTRY] or the [▲][▼] buttons to move the cursor inside the list to select the Memory you want to recall.

7. Press the "RECALL" Function button to recall the Memory.

The Memory is recalled and the display shows the Memory highlighted.



MEMO

To display the Internal Memories again, press the "INTERNAL" Function button.

Renaming a Memory

This function allows you to change the name of a Memory.

1. Press the [MENU] button and select MEMORY→RENAME.

The list of Internal Memory is shown:



2. Use the the [DATA ENTRY] or [▲][▼] buttons to move the cursor inside the list in the position you want to rename the Memory.

3. Press the "RENAME" Function button to confirm.

The display changes to:



4. Use the [DATA ENTRY] knob and the [◀][▶] buttons to rename the Memory. See "Assigning the Name You Specify" (p. 23) for details.

5. Press the "OK" Function button to confirm the name.

The memory will be renamed and the list of Internal Memory is shown.



Exporting All Internal Memories in a Set in the USB Memory

Use this function for exporting the Internal Memory Set in the USB Memory (commercially available).

This function is useful to create special sets for each event and import them at your convenience.

You can also use this function to backup the Internal Memories.

1. Connect an USB memory to the S9. For details see p.19.

An USB icon appears in the Icons field of Main page. See "Main Page" (p. 22).

2. Press the [MENU] button and select MEMORY→EXPORT SET.



The display shows a list of all files and folders on the USB storage device you have just connected.



3. Use the [DATA ENTRY] or the [▲][▼] buttons to scroll through folders to select the destination folder.

Use the "OPEN" Function button to enter in a folder.

If you opened a folder by mistake, press the [←] button to return to a higher level.

4. Press the "EXPORT" Function button to confirm your selection.

The display changes to:



A Memory Set name is suggested by the S9.

5. If you want to name the Memory Set, see "Assigning the Name You Specify" (p. 23).

6. Press the "OK" Function button to export the Memory Set.

A message confirm the operation.

NOTE

You should always safely eject the USB Memory before physically unplugging it from USB socket. Before to unplug the USB Memory use the "USB REMOVE" function. See "Safely Remove the USB Memory" (p. 19).

The display shows a list of all files and folders on the USB storage device you have just connected.



3. Use the [DATA ENTRY] or the [▲][▼] buttons to scroll through folders to select the Memory Set to import.



Use the "OPEN" Function button to enter in a folder.

If you opened a folder by mistake, press the [←] button to return to a higher level.

4. Press the "IMPORT" Function button to confirm your selection.

A message confirm that the Memory Set was imported.

NOTE

You should always safely eject the USB Memory before physically unplugging it from USB socket. Before to unplug the USB Memory use the "USB REMOVE" function. See "Safely Remove the USB Memory" (p. 19).

How to Automatically Recall Your Favorite Setting at the Power On.

The S9 give you the possibility to have your favorite setting directly at the startup of the instrument. To do this, follow the procedure below:

1. Set all the parameters you want when you turn on the instrument.

2. Press the [MENU] button and select MEMORY→SAVE AS DEFAULT.



The instrument asks you if you want your settings as default.



3. Press the "Yes" Function button to confirm the operation. Press "No" to quit the function,

Importing a Memory Set from the USB Memory.

Use this function for importing Sets from the USB Memory (commercially available) to Internal Memory.

1. Connect an USB memory that contains Memory Sets to the S9. For details see p.19.

An USB icon appears in the Icons field of Main page. See "Main Page" (p. 22).

2. Press the [MENU] button and select MEMORY→IMPORT SET.

16 Playing a Music Audio File

The S9 can play back audio files in the mp3 and WAV formats directly from a USB memory you connect to its USB MEMORY port.

You can play along a backing song.

The S9 can play back the following file types:

| File Type | Extension |
|-------------|---------------|
| Audio files | .mp3 |
| | .wav |
| | .aiff or .aif |

Before Playing Songs

Before being able to play back audio (mp3 or WAV) on the S9, you must load songs into an USB Memory.

For performing these operations you need a personal computer.

Copying Audio Files to an USB Memory

1. Insert your USB Memory into the USB socket of your computer.
2. Copy all audio files into the USB Memory.

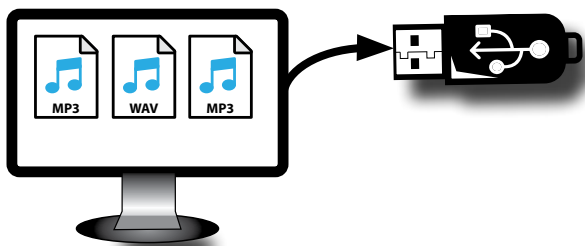

3. Disconnect your USB Memory safely.

Selecting and Playing a Song

1. Insert an USB Memory that contains songs. See "Connecting an USB Memory (commercially available)" (p. 19) and see "Before Playing Songs" (p. 51).

Select the song

2. Press the [SONG] button to enter in SONG mode.

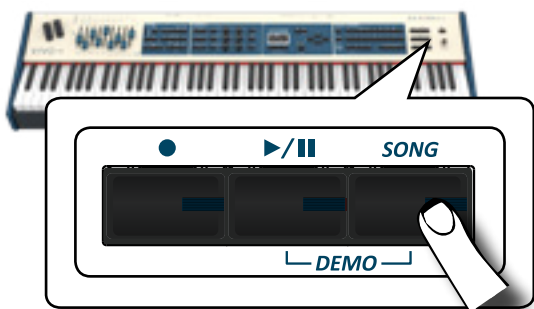

The display shows the Song main page and the name of the current song is shown if already loaded.



3. Press the "SONG LIST" function button. The display shows the contents of the Song internal memory.



4. Press the "USB" function button if you want to select a song into the USB memory. The display shows the contents of the USB memory.



5. Use the [DATA ENTRY] or the [▲][▼] buttons to scroll through files and folders.
6. If the song you need is located inside a folder, you must first select that folder, press the "OPEN" Function button to see its contents and then select the song. If you opened a folder by mistake, press the "←" Function button to return to a higher level.
7. Press the "SELECT" Function button to load the song you want to play.



The song icon is highlighted to indicate the song selected

Play the song

8. Press the [▶/||] button.
The [▶/||] button's indicator lights and song playback starts.
9. Press the [▶/||] button again to pause song playback.
The [▶/||] button goes dark.
10. Press [▶/||] again to resume playback.
11. From the Song main page, turn the [DATA ENTRY] knob to adjust the volume of song playback.
The song level page is temporarily shown:



MEMO

The [DATA ENTRY/SONG VOLUME] knob when a parameter is selected works as Data Entry. In all other cases this knob allows you to set the volume of the song player.

Useful Song Controls

S9 has useful song controls that allow you to adjust the volume, rewind or fast-forward within the currently selected song, etc.

1. Load the song you want to play back. See "Selecting and Playing a Song" (p. 51).



2. From the Song main page, press the "CONTROL" Function button.

The display shows:



3. Use the [▲][▼] buttons select the control parameter.
4. Use the [◀][▶] buttons to choose your setting.

| Parameter | Value | Explanation |
|-----------|--|---|
| Volume | 0~127 | Adjust the Volume of the song player. You can directly adjust the song volume by the [DATA ENTRY/SONG VOLUME] knob. |
| Time | It depends on the duration of the song | <ul style="list-style-type: none"> • Press the [◀] to rewind within the song • Press the [▶] to fast-forward within the song |
| Loop Mode | OFF, SONG, LIST | <p>"OFF": No loops. Playback stops at the end of the selected song current.</p> <p>"SONG": Continuously repeats playback of the current selected song. The playback is repeated until select a different song or stop the song playback.</p> <p>"LIST": Continuously repeats playback of all music files available in a folder, in consecutive order. The playback is repeated until select a different song or stop the song playback.</p> |

17 Recording Your Performance

The S9 allows you to record your performance and save it to an USB storage device.

Recording as Audio Data

Your performance will be recorded as audio data. The recorded song can be used on your computer, phone and in any audio player.

NOTE

To use this method of recording, you must connect an USB drive (sold separately) to the USB Memory port (p. 19).

Recording Your Music as Audio Data (WAVE).

This useful function allows professional quality stereo recordings.

You can reproduce directly by a portable music player by using a computer.

Recording are saved in the external USB Memory (commercially available).

In addition, the S9 allows you to record everything that is connected to the AUDIO IN socket. You can reproduce a backing audio track by an external player connected to the AUDIO IN socket, play along with your instrument in order to practice and then record your performance.

NOTE

- You will need an USB Memory (commercially available) to record your performance.

Audio Recorder format specifications

| Audio Format | Specification |
|--------------|------------------------|
| WAV | 48 kHz, 32 bit, Stereo |

Before you start recording

1. Connect the USB Memory to which you wish to save the audio data. See "Connecting an USB Memory (commercially available)" (p. 19).
2. Prepare everything you want to record: select the tone and the keyboard mode that you want to use for performing.

Starting/stopping recording

3. Press the [●] (Rec) button to start recording.
The indicator of the [●] button lights and the S9 starts to recording everything you play on the keyboard.
4. At the end of the song, press the [●] (Rec) button to stop recording.
The recording stops and the [●] (Rec) button lights off.
Your audio file is saved to the "Recording" folder on the USB memory.

NOTE

Do not disconnect the USB Memory during the song recording.

About the Recording Files

The audio files are saved in the "Recording" folder on the USB Memory.

If the "Recording" folder doesn't exist, it is automatically created within the first recording.



The songs are saved with a different progressive number: rec_0001.wav, rec_0002.wav and so on.

Listening to your recording

5. Press the [▶/||] button to listen to your song.

If you want to re-record again, repeat from step 3.

NOTE

You should always safely eject the USB Memory before physically unplugging it from USB socket. Before to unplug the USB Memory use the "USB REMOVE" function. See "Safely Remove the USB Memory" (p. 19).

How to Record your Performance over an Existing Audio Song (Overdub)

This is a technique used in audio recording. is a process that allows performances to be recorded synchronously with pre recorded materia. All is recorded in a new song.

1. Connect the USB Memory to which you wish to save the audio data. See "Connecting an USB Memory (commercially available)" (p. 19).
2. Prepare everything you want to record.
3. Load a existing audio song. See "Select the song" (p. 51).
4. Press the [●] (Rec) button to start recording.
5. Press the [▶/||] button to start the playback of the audio song pre-recorded.
6. Play your performance while listening to the audio song pre-recorded.
7. At the end of song, press the [●] (Rec) button to stop recording.
The recording stop and the [●] indicator lights off.
8. Press the [▶/||] button to listen your new song.

18 Master Keyboard Zone

The S9 is also designed to be used as a Master Keyboard. Using the [MASTER KEBOARD ZONE] buttons you can divide the keyboard into up four zones with separate MIDI channels and other associated settings so that you can control multiple parts of an external devices at the same time.

The illustration below shows an example of a 4-zone configuration. A zone refers to a specific key range on the keyboard.

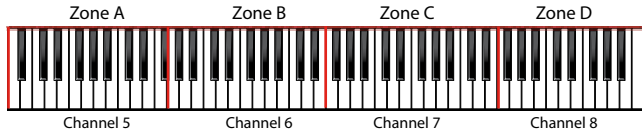

You can connect directly your S9 to an external device by the USB bus or by the MIDI socket. See "Connecting the S9 to Your Computer" (p. 18) or "Connecting the S9 to MIDI devices" (p. 19). You can use many commercial software application for sequencing, notation and so on.

Programmable Four MIDI zones

S9 has four programmable separated MIDI zones. For each zone you can select the MIDI channel, the keyboard range, adjust the Octave, Transpose and many other parameters.

MEMO

The zone settings can be saved in the memories. See "Working with the Memories" (p. 47).

MEMO

To facilitate the MIDI settings using the zones, you have a special MIDI SET called "KeyboardZone". Please see "MIDI SET" (p. 70).

1. To enable a zone, press the relative [A], [B], [C], [D] button.

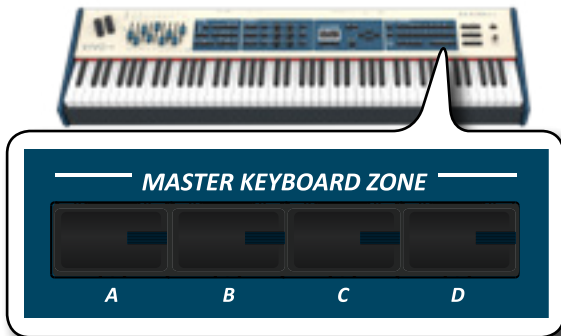

Its indicator lights and the zone is enabled. The MIDI information of the key pressed in the enables zone is sent to the external device. To disable the zone press the relative zone button.

MEMO

Each zone can overlap to one another.

Configure the MIDI zones

1. Press and hold the button relative to the zone you want to edit.

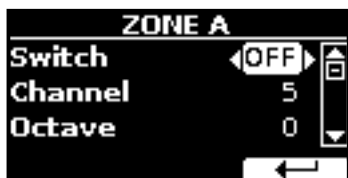

In the example we pressed the Zone A button.

MEMO

You can also select this function pressing [MENU] button → SETTINGS.

2. Use the [▲][▼] buttons to select the parameter.
3. Use the [DATA ENTRY] knob or the [◀][▶] buttons to adjust the value.

Here is a brief explanation of MIDI zone configuration parameters:

| Parameter | Setting | Explanation |
|-------------|-------------------------|--|
| Switch | OFF, ON | Disable or enable the MIDI zone. |
| Channel | 1~16 | Select the MIDI transmit channel. |
| Octave | -4 ~ 0 ~ +4 | Adjust the Octave value. |
| Transpose | -12 ~ 0 ~ +12 | Adjust the Transpose value. |
| Note Low | A-0 ~ B-7 | Set the keyboard range. |
| Note High | B ^b -0 ~ C-8 | MEMO An easy way to set the range, - Select the parameter (Note Low or Note High). - Press a key on the keyboard. |
| CC00 | 0 ~ 127 | These messages are used to select a sound on the external device when you active the zone. |
| CC32 | 0 ~ 127 | |
| PC | 1 ~ 128 | Select the triplet (cc00, cc32, PC) to define the sound. |
| Level | 0 ~ 127 | Set the volume level to send to the external device. |
| Panpot | -64 ~ 0 ~ 63 | Set the panpot value to send to the external device. |
| Reverb | 0 ~ 127 | Set the Reverb value to send to the external device. |
| PC Send | OFF, ON | OFF: use this setting if you do not want the triplet (cc00, cc32, PC) is sent via MIDI. ON: use this setting to send the triplet (cc00, cc32, PC) via MIDI. |
| Level Send | OFF, ON | OFF: the volume message is not sent via MIDI. ON: the volume message is sent via MIDI. |
| Panpot Send | OFF, ON | OFF: the panpot message is not sent via MIDI. ON: the panpot message is sent via MIDI. |
| Reverb Send | OFF, ON | OFF: the reverb message is not sent via MIDI. ON: the reverb message is sent via MIDI. |
| Bender | OFF, ON | OFF: The bender wheel is decoupled. ON: The bender wheel is coupled with the zone. The bender values are transmitted via MIDI. |
| Modulation | OFF, ON | OFF: The modulation wheel is decoupled. ON: The modulation wheel is coupled with the zone. The modulation values are transmitted via MIDI. |
| Aftertouch | OFF, ON | OFF: The aftertouch is decoupled. ON: The aftertouch is coupled with the zone. The aftertouch values are transmitted via MIDI. |
| Foot SW | OFF, ON | OFF: The function of the pedal is decoupled. ON: The function linked to the pedal is coupled with the zone. The values are transmitted via MIDI. |
| Damper | OFF, ON | |
| Expression | OFF, ON | |

| Parameter | Setting | Explanation |
|-------------------|------------------|---|
| C1 ~ C6 | OFF, ON | <p>These parameters are related to the six control knobs located on the "AUDIO FX" panel.</p> <p>OFF: The control knob is decoupled.</p> <p>ON: The control knob is coupled with the zone when the MIDI channel is set to "Zone". See "CONTROL 1/2/3/4/5/6" (p. 65). The values are transmitted via MIDI.</p> |
| S1 ~ S9 | OFF, ON | <p>These parameters are related to the nine sliders (draw-fader).</p> <p>OFF: The slider is decoupled.</p> <p>ON: The slider knob is coupled with the zone when the MIDI channel is set to "Zone". See "SLIDER 1, 2, 3, 4, 5, 6, 7, 8, 9" (p. 66). The values are transmitted via MIDI.</p> |
| CC Assign1 | OFF, CC1 ~ CC127 | <p>These four control change messages are available to be transmitted to the external device when the zone is activated.</p> <p>OFF: No control change is transmitted.</p> <p>CC1 ~ CC127: Select the control change to send via MIDI.</p> <p>0 ~ 127: Select the value.</p> |
| CC Value 1 | 0 ~ 127 | |
| CC Assign2 | OFF, CC1 ~ CC127 | |
| CC Value 2 | 0 ~ 127 | |
| CC Assign3 | OFF, CC1 ~ CC127 | |
| CC Value 3 | 0 ~ 127 | |
| CC Assign4 | OFF, CC1 ~ CC127 | |
| CC Value 4 | 0 ~ 127 | |

19 Playing with Audio Backing Tracks

Thanks to X MURE® application and the S9 you can play your favourite melodies while controlling an audio pattern.



X MURE® is a DEXIBELL® software product

WHAT IS X MURE

- X-MURE is an application that runs on iPhone or iPad.
- Using "Harmony Poly Fragmentor" (the world first algorithm able to modify "audio tracks" in real time), "X MURE" allows you to play music directly on the screen of your iPad/iPhone or with a musical instrument connected via USB.
- "X MURE" does not use sound generators, virtual instruments or "Standard MIDI file", it is exclusively based on audio tracks recorded by real musical instruments, so it does not simulate reality... it is the reality.

WHAT YOU CAN DO WITH X MURE

- Control X MURE audio patterns by live chord progression played by the S9.
- Re-arrange your favourite music tracks using countless musical genres or create a completely new song hit.

WHAT YOU NEED TO USE X MURE

- The S9 Digital Organ.
- Apple iPad Camera Connection Kit (Camera connectors made by Apple Inc.).
- USB cable (type A–male - type B–male: commercially available).
- Audio cable (3.5 mm jacks).
- Download X MURE application from App Store.

Connecting your Mobile Device

1. Connect your iPad with your S9 by using a USB iPad camera connector and a USB cable.

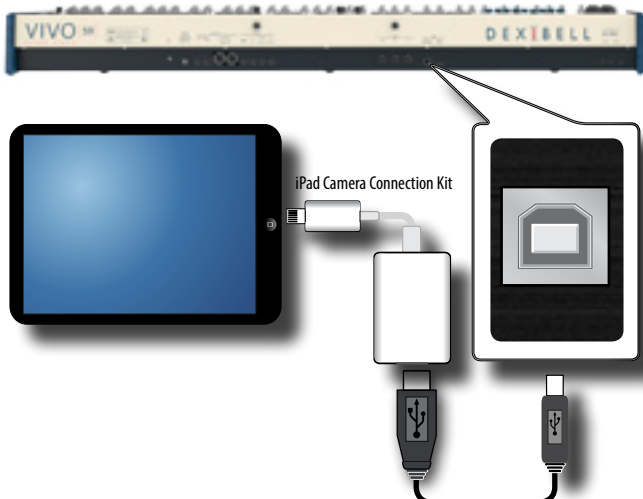

2. Rotate the [VOLUME] knob toward the lower position to minimize the volume.
3. Connect the S9's INPUT jack positioned to the rear panel to the output socket of your mobile device. See "Connecting Digital Player Devices" (p. 18).

Playing with X MURE Application

1. Turn your S9 and your iPad on.
2. Touch the X MURE icon in your iPad to open the app.

Now you have three possible choices:



3. Touch Dexibell VIVO icon to have the maximum performance with S9.

The following page appears:



4. Play a note in the keyboard to inform X MURE which part you want use to control it.
5. On X MURE select the audio pattern you want play back.
6. Touch the play icon of the X MURE application.

The pattern start to play back.

MEMO

You can use a pedal to Play or Stop the play back of the pattern. See "CONTROL" (p. 63).

7. Play chords in the keyboard. The audio pattern follows your chord progression.
8. On X MURE touch the "A", "B", "C", "D" icon button to chose a different scene.

MEMO

You can use a pedal to select different scene. See "CONTROL" (p. 63).

9. On X MURE touch the "1", "2", "3", "4" icon button to chose a different drum pattern.

MEMO

You can use a pedal to select different drum pattern. See "CONTROL" (p. 63).

Bluetooth® Audio Connectivity

The S9 is equipped with Bluetooth® Audio function. Thanks to this technology, you'll be able to stream music wirelessly from a Bluetooth® capable smartphone, tablet or computer to the S9.



Preliminary Operation, Pairing a Mobile Device

The first time you use a new mobile device, you need to "pair" it with your device so that both devices know how to connect securely to each other.



NOTE

Please take in consideration that the explanation to pair your mobile device with the S9 is as an example. The operations to pair your mobile device can be different from our explanation and depend on the operating system of your device. For details, please refer to the owner's manual of your mobile device.

1. Place the mobile device within 1 meter (3 ft) from the S9.

NOTE

When pairing, make sure that other devices are off or out of range.

2. Make sure that S9 is visible to other devices. To do it, press the [MENU] button and select Bluetooth® page.



3. If necessary, use the [▲][▼] buttons to select the "Visible" parameter.

4. Use the [DATA ENTRY] or the [◀][▶] buttons to set it "On". Your piano is now visible to other devices.
5. On the mobile device that you want to connect, turn on the Bluetooth® function and, if necessary, search for the available devices.

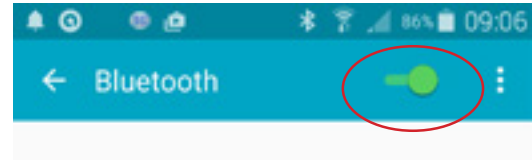

For details on how to enable the Bluetooth® function, refer to the owner's manual of your mobile device.

The list of available devices is now shown in your mobile device.

6. Select the "Dexi-piano-xx" device that is shown in the Bluetooth® list of your mobile device.

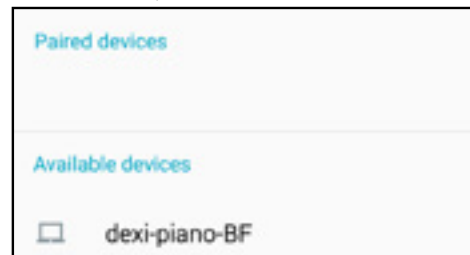

In example above the device name is "dexi-combo-AA".

7. If the mobile device and the S9 ask you to confirm the connection showing the "passkey" screen, confirm on your mobile device.

When pairing succeeds "Dexi-piano-xx" is added to the list of paired devices in the mobile device.

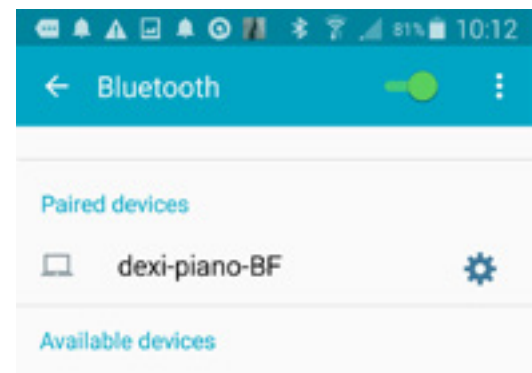

8. Select the "Dexi-piano-xx" device that is shown in the paired devices list of your mobile device.

The connection is now established and a Bluetooth® icon is shown in the main menu. The music data played back by the mobile device can be heard through the S9.

MEMO

For details, refer to the owner's manual of your mobile device.

MEMO

Once the devices have been paired, there is no need to perform pairing again. Once the device is recognized, the S9 ask you to authorize the connection:



Choose "YES" to authorize the connection. The following page appears:



See "Connecting an Already Paired Mobile Device" (p. 58) to connect the S9 with a mobile device

NOTE

Pairing is required again if you execute a Factory Reset (p. 34).

Connecting an Already Paired Mobile Device

NOTE

Please take in consideration that the explanation to connect your mobile device with the S9 is as an example. The operations to connect your mobile device can be different from our explanation and depend on the operating system of your device. For details, please refer to the owner's manual of your mobile device.

1. Place the mobile device within 1 meter (3 ft) from the S9.
2. If necessary, turn on the Bluetooth® function on the mobile device.
3. Select the "Dexi-piano-xx" device that is shown in the Bluetooth® list of your mobile device.

The music data played back by the mobile device can be heard through the S9.

MEMO

For details, refer to the owner's manual of your mobile device.

21 Master Equalizer

S9 is provided of an useful Master Equalizer. You can adjust Low Gain, Middle Frequencies, Middle Gain and High gain to obtain the best possible sound when listening through an external reproduction system or adapt the sound response of a room.

Real Time Control

You can adjust the master equalizer parameters by the draw-faders. To do this:

1. Press at the same time the [MIXER] and the [MIDI CTRL] buttons.

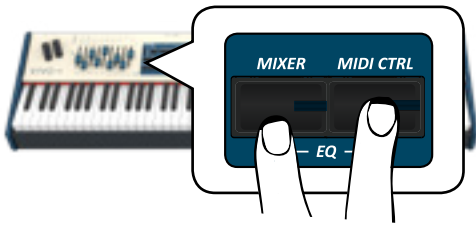

Now the last four draw-faders are assigned to the parameters of equalizer.

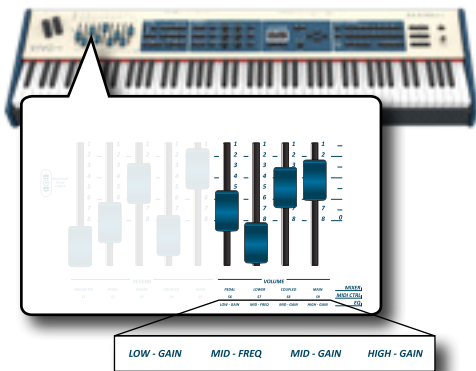

2. Move one of the draw-faders to adjust the desired parameter.

The following temporary window is shown:



3. Use the other draw-faders to choose the best equalization.

For more information regarding the Master Equalizer parameters, see "MASTER EQ" (p. 63).

4. Press at the same time the [MIXER] and the [MIDI CTRL] buttons again to leave this ambient.

Master Equalizer Adjusting

The equalizer give you the possibility to boosting or reducing the low-frequency or high-frequency range of the sound. Adjust the Master EQ parameters to reach the best possible sound when listening through different reproduction systems, headphones, or an external speaker system.

1. Access the "MASTER EQ" page by the [MENU] button →EFFECTS→MASTER EQ.

The list of parameter is shown.



1. Use the [▲], [▼] buttons to select the parameter and use the [DATA ENTRY] knob or the [◀] [▶] buttons to adjust the value.

| Parameter | Setting | Explanation |
|-----------|----------------|---|
| High Gain | -12~ 0 +12 dB | Use this parameter to set the level of the high frequency. Positive values boost (increase) the volume of that frequency. Negative values cut (attenuate) it. |
| High Freq | 400 ~ 10000 Hz | This parameter allows you to set the cutoff frequency of the high band. |
| Mid Freq | 100 ~ 8000 Hz | This parameter allows you to set the cutoff frequency of the middle band. |
| Mid Gain | -12~ 0 +12 dB | Use this parameter to set the level of the selected MID frequency. Positive values boost (increase the volume of) that frequency. Negative values cut (attenuate) it. |
| Mid Q | 0.5 ~ 12.0 | Move this parameter to adjust the width of the area around the Middle frequency that will be affected by the Gain setting. Higher values of Mid Q set narrowest area |
| Low Gain | -12~ 0 +12 dB | Use this parameter to set the level of the low frequency. Positive values boost (increase) the volume of that frequency. Negative values cut (attenuate) it. |
| Low Freq | 40 ~ 600 Hz | This parameter allows you to set the cutoff frequency of the low band. |

Master Equalizer Preset

S9 comes with some Presets that can be handy in particular situations or a good way to get you started. You might want to start with a preset, then customize it until it is just right and save it in the user area.

1. From the "MASTER EQ" page press the "PRESET" Function button.



2. Use the [DATA ENTRY] knob or the [▲], [▼] buttons to select the desired preset.

3. Press the "SELECT" Function button to confirm your choice.

Its "EQ" icon is highlighted to indicate that the preset has been loaded.

Saving Your User Preset

Make the necessary adjustments to obtain the sound that suits you best.

1. From the "MASTER EQ" page, press the "SAVE" Function button.



2. If you wish, you can give a name to the preset pressing the "RENAME" Function button. For details how to rename see "Assigning the Name You Specify" (p. 22).

3. Press the "WRITE" Function button to save your preset.

The display shows a confirmation message.

MEMO

The current equalizer preset is automatically saved when the S9 is turned off and reloaded when the power is turned on.

The S9's [MENU] button provides access to the available parameters and functions.

General procedure

1. Press the [MENU] button.

The display changes to:



2. Use the [DATA ENTRY] knob or the [▲] [▼] buttons to select the entry of the desired function group.

3. Press the [▶] button to go to the display page where you can edit the parameters of the selected group, or to execute the selected command.

For more details about the parameters selection, see "Moving the Cursor and Setting Parameter Values" (p. 22).

The following parameters and functions are available

Parameters Group



| | |
|---------------------------------------|-----------|
| SETTING Parameters Group | 62 |
| MAIN SETTING | 62 |
| Level | 62 |
| Panpot | 62 |
| Octave | 62 |
| Mute | 62 |
| Coarse Tune | 62 |
| Fine Tune | 62 |
| Note Low | 62 |
| Note High | 62 |
| COUPLED SETTING | 63 |
| Level | 63 |
| Panpot | 63 |
| Octave | 63 |
| Mute | 63 |
| Coarse Tune | 63 |
| Fine Tune | 63 |
| Note Low | 63 |
| Note High | 63 |
| LOWER SETTING | 63 |
| PEDAL SETTING | 63 |
| KEYBOARD TOUCH | 63 |
| OCTAVE | 63 |
| Main | 63 |
| Coupled | 63 |
| Lower | 63 |
| Pedal | 63 |
| ZONE 1 | 63 |
| ZONE 2 | 63 |
| ZONE 3 | 63 |
| ZONE 4 | 63 |
| TRANSPOSE | 63 |
| SPLIT MODE | 63 |
| Split Point | 63 |
| Split | 63 |
| T2L EDITOR | 63 |
| EFFECT | 63 |
| MAIN FX | 63 |
| COUPLED FX | 63 |
| LOWER FX | 63 |
| PEDAL FX | 63 |

| | |
|--|-----------|
| REVERB | 63 |
| MASTER EQ | 63 |
| CONTROL | 63 |
| DAMPER PEDAL | 64 |
| Main | 64 |
| Coupled | 64 |
| Lower | 64 |
| Pedal | 64 |
| ASSIGN 1 PEDAL | 64 |
| Funct | 64 |
| Main | 64 |
| Coupled | 64 |
| Lower | 64 |
| Pedal | 64 |
| ASSIGN 2 PEDAL | 64 |
| ASSIGN 3 PEDAL | 64 |
| EXPRESSION PEDAL | 64 |
| Funct | 64 |
| Organ | 65 |
| Main | 65 |
| Coupled | 65 |
| Lower | 65 |
| Pedal | 65 |
| MORPHING PEDAL | 65 |
| Funct | 65 |
| Organ | 65 |
| Main | 65 |
| Coupled | 65 |
| Lower | 65 |
| Pedal | 65 |
| ASSIGN 1, 2 SWITCH | 65 |
| Funct | 65 |
| WHEEL 1 | 65 |
| Funct | 65 |
| Pitch | 65 |
| Main | 65 |
| Coupled | 65 |
| Lower | 65 |
| Pedal | 65 |
| WHEEL 2 | 65 |
| Funct | 65 |
| Main | 65 |
| Coupled | 65 |
| Lower | 65 |
| Pedal | 65 |
| AFTERTOUCH | 65 |
| CONTROL 1/2/3/4/5/6 | 65 |
| Channel | 65 |
| Function | 66 |
| SLIDER 1, 2, 3, 4, 5, 6, 7, 8, 9 | 66 |
| Channel | 66 |
| Function | 66 |
| TUNING | 66 |
| MASTER TUNE | 66 |
| TEMPERAMENT | 66 |
| Equal Flat | 66 |
| Equal Stretch (default) | 66 |
| VIVO Stretch | 66 |
| Vallotti | 66 |
| Just Major | 66 |
| Pythagorean | 66 |
| Mean-Tone | 66 |
| Werckmeister III | 66 |
| Kimberger III | 66 |
| User 1, User 2, User 3 | 66 |
| MEMORY | 67 |
| USB REMOVE | 67 |
| USB AUDIO | 68 |
| Input Level | 68 |
| Output Level | 68 |

| | |
|-----------------------------------|-----------|
| AUDIO INPUT | 68 |
| LEVEL | 68 |
| BLUETOOTH | 68 |
| MIDI | 68 |
| RECEPTION | 68 |
| Main, Coupled, Lower, Pedal | 68 |
| Status | 68 |
| Channel | 69 |
| Shift | 69 |
| Modulation | 69 |
| Volume | 69 |
| Panpot | 69 |
| Expression | 69 |
| Aftertouch | 69 |
| Reverb | 69 |
| Hold | 69 |
| Sostenuto | 69 |
| Soft | 69 |
| PG (Program Change) | 69 |
| PB (Pitch Bender) | 69 |
| Memory | 69 |
| Status | 69 |
| Channel | 69 |
| Memory | 69 |
| Status | 69 |
| Channel | 69 |
| TRANSMISSION | 69 |
| Main, Coupled, Lower | 69 |
| Status | 69 |
| Channel | 69 |
| Shift | 69 |
| Local | 69 |
| Modulation | 69 |
| Volume | 69 |
| Panpot | 69 |
| Expression | 69 |
| Aftertouch | 69 |
| Reverb | 69 |
| Hold | 69 |
| Sostenuto | 69 |
| Soft | 69 |
| PG (Program Change) | 69 |
| PB (Pitch Bender) | 69 |
| Memory | 69 |
| Status | 69 |
| Channel | 70 |
| Memory | 70 |
| Status | 70 |
| Channel | 70 |
| Common | 70 |
| Active Sensing (FEH) | 70 |
| MIDI SET | 70 |
| SAVE MIDI SET | 70 |
| GLOBAL | 70 |
| Auto OFF | 70 |
| Switch | 70 |
| Pedal | 70 |
| Motor Slider | 70 |
| Wheel | 71 |
| SOUND LIBRARY | 71 |
| SOUND SETUP | 71 |
| FACTORY RESET | 71 |
| FACTORY SOUND | 71 |
| VERSION INFO | 71 |

PARAMETERS MEMORY AREA

The parameters of the instrument are stored in two memory areas. Each icon will show you on which area the parameters will be stored.

| Icons | Explanation |
|--|---|
|  | This symbol indicates that the parameter or the parameters group can be stored in the Internal Memory area. See "Working with the Memories" (p. 47). |
|  | This symbol indicates that the parameter or the parameters group can be stored in the Global Internal Memory area. The Global Internal Memory Area is automatically saved when you turn off the instrument. |
| NOTE | Use the appropriate button to turn off the instrument. Do not disconnect the power adapter from the outlet before the instrument is turned off. |

SETTING Parameters Group

[MENU] button →SETTING

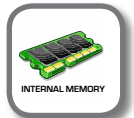

In this parameters group you can access to the important settings of your instrument.



▶ MAIN SETTING

This is where you can edit parameters related to keyboard Main part.

| Parameter | Setting | Explanation |
|-------------|---------------|--|
| Level | 0 ~ 127 | Adjusts the volume of the Main keyboard part. Selecting "0" means that the part is no longer audible. |
| Panpot | -64 ~ 0 ~ +63 | Use this parameter to set the stereo placement of the selected instrument. "0" means "no change", negative values shift the instrument towards the left, and positive values shift it towards the right. |
| Octave | -4 ~ 0 ~ +4 | Use this parameter to transpose the Main part up or down by up to 4 octaves. |
| Mute | OFF, ON | Select "ON" to mute the keyboard part. |
| Coarse Tune | -24 ~ 0 ~ +24 | The Coarse and Fine Tune are used to create interference pattern between two sounds of slightly different frequencies. Changes the pitch in semi-tone steps. |
| Fine Tune | -99 ~ 0 ~ +99 | Changes the pitch in steps of 1 cent (1/100 semi-tone). |
| Note Low | A0 ~ B7 | You can set the keyboard range for the Main part. |
| Note High | Bb0 ~ C8 | |

▶ **COUPLED SETTING**

Contains the parameters for the Coupled part.

| Parameter | Setting | Explanation |
|-------------|---------------|---|
| Level | 0 ~ 127 | Same settings as Main part. See above. |
| Panpot | -64 ~ 0 ~ +63 | |
| Octave | -4 ~ 0 ~ +4 | |
| Mute | OFF, ON | Select "ON" to mute the keyboard part. |
| Coarse Tune | -24 ~ 0 ~ +24 | The Coarse and Fine Tune are used to create interference pattern between two sounds of slightly different frequencies. Changes the pitch in semi-tone steps. |
| Fine Tune | -99 ~ 0 ~ +99 | Changes the pitch in steps of 1 cent (1/100 semi-tone). |
| Note Low | A0 ~ B7 | You can set the keyboard range for the Coupled part. |
| Note High | Bb0 ~ C8 | |

▶ **LOWER SETTING**

Contains the parameters for the keyboard Lower part.

Same settings as Main and Coupled parts. See above.

▶ **PEDAL SETTING**

Contains the parameters for the keyboard Pedal part

Same settings as Main, Coupled and Lower parts. See above.

▶ **KEYBOARD TOUCH**

See "Adjusting the Keyboard Response (Key Touch)" (p. 35) and "Customize the Global Keyboard Response (Key Touch)" (p. 35).

▶ **OCTAVE**

| Parameter | Setting | Explanation |
|-----------|-------------|--|
| Main | -4 ~ 0 ~ +4 | Use this parameter to transpose the selected keyboard part up or down by up to 4 octaves. |
| Coupled | -4 ~ 0 ~ +4 | |
| Lower | -4 ~ 0 ~ +4 | |
| Pedal | -4 ~ 0 ~ +4 | |
| ZONE 1 | 4 ~ 0 ~ +4 | Use this parameter to transpose the selected Zone up or down by up to 4 octaves. See "Master Keyboard Zone" (p. 54). |
| ZONE 2 | 4 ~ 0 ~ +4 | |
| ZONE 3 | 4 ~ 0 ~ +4 | |
| ZONE 4 | 4 ~ 0 ~ +4 | |

▶ **TRANSPOSE**

This function allows you to transpose the S9's pitch in semi-tone steps. For more details see "Transposing the pitch of the keyboard" (p. 34).

▶ **SPLIT MODE**

These parameters allows you to manage the splitting mode of the keyboard.



| Parameter | Setting | Explanation |
|-------------|------------------------|--|
| Split Point | F1 ~ E7 Default: F3 | See "How to change the Split Point" (p. 26). |
| Split | OFF, ON Default: ON | See "Play All Parts in Layer Mode" (p. 26). |

T2L EDITOR

[MENU] button → T2L EDITOR

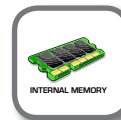

See "Personalizing Your Sounds (T2L)" (p. 42).

EFFECT

[MENU] button → EFFECT

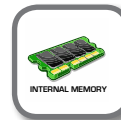

Your instrument contains two multi-effects (FX-A and FX-B) processor that can be used for processing any Keyboard part you like.

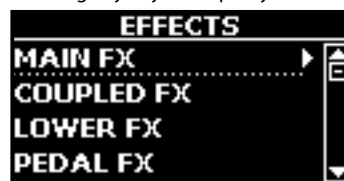

▶ **MAIN FX**

This selection provides access to the display pages where you can set the effects parameters of the S9's Main part.



For details regarding effects parameters, refer to the "Effects Types and Parameters" table p. 72.

For more details about the selection of FXs and the relative parameters, see "Adding Effects to Orchestral Sound" (p. 32).

▶ **COUPLED FX**

Contains the effect parameters for the Coupled part.

Same settings as Main part. See above.

▶ **LOWER FX**

Contains the effect parameters for the keyboard Lower part.

Same settings as Main part. See above.

▶ **PEDAL FX**

Contains the effect parameters for the keyboard Pedal part.

Same settings as Main part. See above.

▶ **REVERB**

See "Adding Reverb to the Sound" (p. 32).

▶ **MASTER EQ**

Please see "Master Equalizer Adjusting" (p. 59).

CONTROL

[MENU] button → CONTROL



This group of parameter is related to the assign switches, pedals, sliders, knobs and wheel controls. The S9 allows you to manage and assign various functions to these control units.

Here the page where you can assign these functions.



► DAMPER PEDAL



| Parameter | Setting | Explanation |
|-----------|---------|---|
| Main | Off, On | Off: Select "OFF" if you don't need damper pedal. |
| Coupled | | On: Select "On" if you need damper pedal to the keyboard part. |
| Lower | | |
| Pedal | | |

► ASSIGN 1 PEDAL

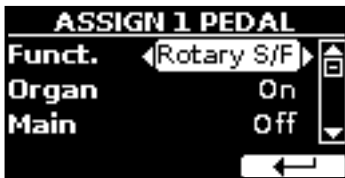

| Parameter | Setting | Explanation |
|-----------|---|--|
| Funct. | OFF, Sostenuto, Soft, Damper, FXA On-Off, FXB On-Off, Mem. Prev, Mem. Next, Rotary On/Off, Rotary S/F, Rotary Brake, Perc. On/Off, VibChoOn/Off, Drive On/Off, Morph On/Off, Part On/Off, XMure FillUp, XMure FillDw, XMure SceneUp, XMure SceneDw, XMure Play, XMure Ending, TW Norm/Soft Default: Rotary S/F | OFF: No function assigned. See "Pedal Functions Explanation" (p. 64). MEMO Some functions are commands that do not need to specify the part (Main, Coupled, Lower or Pedal). |
| Main | Off, On | Off: Select "OFF" if you don't need of pedal. |
| Coupled | | On: the pedal is assigned to the specified part. |
| Lower | | |
| Pedal | | |

► ASSIGN 2 PEDAL



Please refer to the parameter of the ASSIGN 1 PEDAL.

► ASSIGN 3 PEDAL

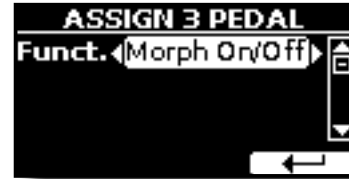

Please refer to the parameter of the ASSIGN 1 PEDAL.

Pedal Functions Explanation

| Function | Explanation |
|--|--|
| Sostenuto | The pedal is used as Sostenuto. |
| Soft | The pedal is used as Soft. The soft pedal reduces the volume and slightly changes the timbre of notes played while the pedal is pressed. |
| Damper | The pedal is used as a damper. |
| FXA On-Off FXB On-Off | Allows you to switch the MFXA/B on and off. |
| Mem. Prev Mem. Next, | Allows you to select the next or previous Memory. |
| Rotary On/Off | Turns the rotary on or off. |
| Rotary S/F | This function alternate between the fast and slow Rotary speeds. It does the same function as the [FAST/SLOW] button in the ROTARY panel section |
| Rotary Brake | This function gradually stops the rotary. It does the same function as the [BRAKE] button in the ROTARY panel section. |
| Perc On/Off | Add or not the percussion. It does the same function as the [ON] button in the PERCUSSION panel section. |
| VibChoOn/Off | Enable or disable the vibrato or chorus effect. It does the same function as the [ON] button in the VIBRATO/CHORUS panel section. |
| Drive On/Off | This is the typical effect of vacuum tube amplifier. Add or not the overdrive effect It does the same function as the [OVERDRIVE] button in the ORGAN panel section. |
| Morph On/Off | Enable or disable the morphing function. It does the same function as the [MORPHING] button in the "ORGAN" section. |
| Part On/Off | Enable or disable the selected keyboard part. |
| XMure FillUp XMure FillDw | Using these functions you can select a the next or the previous drum pattern in the XMure® application. |
| XMure SceneUp XMure SceneDw | These functions allow you to change scene of the accompaniment in the XMure® application. |
| XMure Play | Play or Stop the playback of a XMure® pattern. |
| Xmure Ending | Select the Ending pattern. |
| TW Norm/Soft | This parameter reduce the volume of the tonewheel. See "VOLUME" in the "Tonewheel parameters" (p. 44). |

► EXPRESSION PEDAL



| Parameter | Setting | Explanation |
|-----------|-----------------------------------|--|
| Funct. | Expression, Modulation, FX Manual | Expression: The pedal is assigned to the expression. Modulation: The pedal is assigned to the Modulation. FX Manual : You can control the "Manual" parameter of the effector. See the "16: Wah-Wah" (p. 74) and the "17: Cut Filter" (p. 74). |

| Parameter | Setting | Explanation |
|-----------|---------|---|
| Organ | Off, On | Off: Select "OFF" if you don't need expression pedal. On: the pedal is assigned to the specified part. |
| Main | | |
| Coupled | | |
| Lower | | |
| Pedal | | |

► MORPHING PEDAL



| Parameter | Setting | Explanation |
|-----------|---------------------------------|--|
| Funct. | Morphing, Modulation, FX Manual | Morphing: The pedal is assigned to the morphing function. See "Morphing" (p. 29). Modulation: The pedal is assigned to the Modulation. FX Manual: You can control the "Manual" parameter of the effector. See the "16: Wah-Wah" (p. 74) and the "17: Cut Filter" (p. 74). |
| Organ | Off, On | Off: Select "OFF" if you don't need of the function for the specified part. On: the pedal is assigned to the specified part. |
| Main | | |
| Coupled | | |
| Lower | | |
| Pedal | | |

► ASSIGN 1, 2 SWITCH



| Parameter | Setting | Explanation |
|-----------|---|--|
| Funct. | Mem. Prev Mem. Next | Allows you to select the next or previous Memory. |
| | Main Hold Lower Hold Coupled Hold | This settings allows you to set the Hold function for the Main, Lower and Coupled part by the Assign Switches. |
| | XMure FillUp XMure FillDw | Using these functions you can select a the next or the previous drum pattern in the XMure® application. |
| | XMure SceneUp XMure SceneDw | These functions allow you to change scene of the accompaniment in the XMure® application. |
| | XMure Play | Play or Stop the playback of a XMure® pattern. |
| | XMure Ending | Select the Ending pattern. |

► WHEEL 1



| Parameter | Setting | Explanation |
|-----------|---------|---|
| Funct | Pitch | Change the pitch of the notes you are playing. |
| Pitch | 0 ~ +24 | Select the pitch interval. |
| Main | Off, On | Off: the pitch change does not affect the part. On: the pitch change acts on the part. |
| Coupled | | |
| Lower | | |
| Pedal | | |

► WHEEL 2

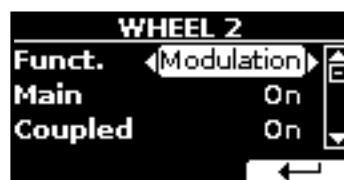

| Parameter | Setting | Explanation |
|-----------|--|--|
| Funct. | Modulation, Expression, FX Manual Default: Modulation | Modulation: Using the WHEEL 2 you will add modulation to the notes you are playing at that time. Expression: The WHEEL 2 is assigned to the expression. FX -Manual: You can control the "Manual" parameter of the effector. See the "16: Wah-Wah" (p. 74) and the "17: Cut Filter" (p. 74). |
| Main | Off, On | Off: the Whell 2 assigned function does not affect the part. On: the Whell 2 assigned function acts on the part. |
| Coupled | | |
| Lower | | |
| Pedal | | |

► AFTERTOUCH



See "Aftertouch" (p. 34).

► CONTROL 1/2/3/4/5/6



This pages allows you to assign a function to the knobs (C1, C2, C3, C4, C5, C6).

| Parameter | Setting | Explanation |
|-----------|--------------|---|
| Channel | 1 ~ 16, Zone | 1 ~ 16: Select the MIDI channel. Zone: The channel is linked to the Zone MIDI channel. Use this setting when use the zone function. See "Master Keyboard Zone" (p. 54).. |

| Parameter | Setting | Explanation |
|-----------|---|---|
| Function | CC1 ~ CC127 NOTE You can't assign CC#32 (Bank select LSB). | CC#: You can choose one of 127 control change. You send control change values moving the Knob C1, C2, C3, C4, C5 or C6. |

► SLIDER 1, 2, 3, 4, 5, 6, 7, 8, 9

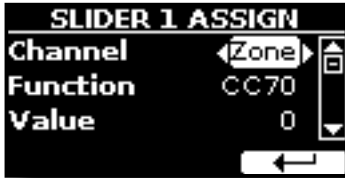

This pages allows you to assign a function to the nine sliders (drawbars).

| Parameter | Setting | Explanation |
|-----------|---|--|
| Channel | 1 ~ 16, Zone | 1 ~ 16: Select the MIDI channel. Zone: The channel is linked to the Zone MIDI channel. Use this setting when use the zone function. See "Master Keyboard Zone" (p. 54). |
| Function | CC1 ~ CC127 NOTE You can't assign CC#32 (Bank select LSB). | CC#: You can choose one of 127 control change. You send control change values moving the sliders. |

TUNING

[MENU] button → TUNING



► MASTER TUNE



| Setting | Explanation |
|---------------------------------|--|
| 415.30 Hz~ 440.00 Hz~ 466.10 Hz | Select the desiderate tuning. |
| "440.00 Hz" Function button | Use the "440.00 Hz" and "442.00 Hz" Function buttons to tuning the instrument at those values. |
| "442.00 Hz" Function button | |

Some Information About the Master Tune

The instruments are generally tuned to an A 440 pitch standard that was adopted during the early 1900s in response to widely varying standards. Previously the pitch standards had gradually risen from about A 415 during the late 1700s and early 1800s to A 435 during the late 1800s. Though A 440 is generally the standard, some orchestras, particularly in Europe, use a higher pitch standard, such as A 444.

► TEMPERAMENT



NOTE

This function doesn't work when a TW1, TW2, FARF or VX type organ is selected.

The modern instruments are tuning in Equal Stretch temperament, in which every pair of adjacent pitches is separated by the same interval.

There are other scale used in different music style. Modern musical scale in western culture are different in one other way from older classic music. At the time of Bach the scales were based on the note A being about 415 Hz. In the Handel's time the frequency A was 422.5 Hz and today it is 440.0 Hz.

| Setting | Explanation |
|-------------------------|---|
| Equal Flat | This tuning divides each octave into 12 equal steps (intervals). |
| Equal Stretch (default) | Equal Stretch: This tuning is a correction of Equal Flat. A benefit of stretching octaves is the correction of dissonance that equal temperament imparts to the perfect fifth. |
| VIVO Stretch | This tuning is similar to the Equal Scretch with small adjustments to make it more suitable for piano sounds. |
| Vallotti | This tuning is the default for many of today's Baroque musicians. |
| Just Major | This is a just scale for pieces in mayor keys. |
| Pythagorean | This system was invented in ancient Greece. It resolves the ambiguity of fourths and fifths. Though thirds are somewhat imperfect, melodies sound clearer. |
| Mean-Tone | A temperament that adds some compromises to the just temperament and facilitates transposition. |
| Werckmeister III | A combination of the Mean Tone and Pythagorean temperaments, this tuning allows for playing in any key. |
| Kimberger III | As a result of improvements made to the Mean Tone and Just temperaments, this tuning system is relatively tolerant towards transposition and can be used to play in all keys. |
| User 1, User 2, User 3 | User 1, User 2, User 3: These settings refer to the tuning systems programmed by yourself (or someone else). |

1. Select your favorite temperament scale .
2. Press the "RECALL" Function button to load the scale.

The temperament scale is recalled.

Editing the Equal Flat, Equal Stretch or Vivo Stretch scale

If you selected the Equal Flat, Equal Stretch or Vivo Stretch scale:

The "EDIT" Function button appears.

1. Press the "EDIT" Function button to program your scale.

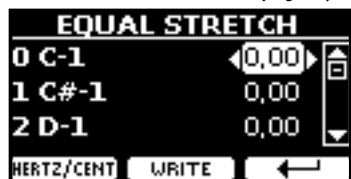

In the example above we select the Equal Stretch scale.

2. To select a note, use the [▲][▼] or play a note on the keyboard.
3. Use the [◀][▶] buttons or the [DATA ENTRY] knob to modify the tuning of the selected note.
4. Press [HERTZ/CENT] Function button to change the tuning in steps of 1/100 of cent.

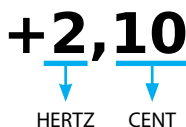

| Setting | Explanation |
|----------------------------|----------------------|
| -99.99 ~ 0 ~ +99.99 (cent) | Set the note tuning. |

5. Press the "WRITE" Function button to save your scale.

The following page appears:



6. Use the [DATA ENTRY] knob or the [▲][▼] buttons to select the USER scale where you want save your scale.
7. Press the "WRITE" Function button to save your scale.
A message of confirmation appears.

If you selected a scale other than equal temperament:

1. If you selected a scale other than equal temperament as Pythagorean, Mean-Tone, Werckmeister III, Kimberger III and the Just Major and Minor temperament scale, you can specify the root note:

The "ROOT NOTE" Function button appears.



2. Press the "ROOT NOTE" Function button if you want specify the base note.



3. Select the root note.

| Setting | Explanation |
|---|--|
| C, C#, D, Eb, E, F, F#, G, Ab, A, Bb, B | Select the base note of the temperament scale. |

4. Press the "←" Function button come back to previous page.

If you selected one of USER scales:

The "EDIT" Function button appears.



1. Press the "EDIT" Function button to program your scale.



2. To select a note, use the [▲][▼] or play a note on the keyboard.
3. Use the [◀][▶] buttons or the [DATA ENTRY] knob to modify the tuning of the selected note.
4. Press [HERTZ/CENT] Function button to change the tuning in steps of 1/100 of cent.

| Setting | Explanation |
|----------------------------|----------------------|
| -99.99 ~ 0 ~ +99.99 (cent) | Set the note tuning. |

5. Press the "WRITE" Function button to save your scale.
A message of confirmation appears.
6. Press the "←" Function button come back to previous page.

MEMORY

[MENU] button → MEMORY

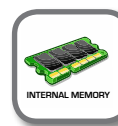

For the explanation of this section please refer to "Working with the Memories" (p. 47).

USB REMOVE

[MENU] button → USB REMOVE

Before to unplug the USB Memory, use this function to safely remove it. See "Safely Remove the USB Memory" (p. 19).

USB AUDIO

[MENU] button → USB AUDIO

Use this function if you need to adjust the audio output and input levels via USB.



| Parameter | Setting |
|--------------|------------------------------|
| Input Level | -inf ~ 0 dB Default: 0 dB |
| Output Level | -inf ~ 0 dB Default: 0 dB |

AUDIO INPUT

[MENU] button → AUDIO INPUT

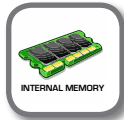

▶ LEVEL

| Setting | Explanation |
|---------|--|
| 0~ 127 | Here you can adjust the input level of the signals received via Audio In socket. |

BLUETOOTH

[MENU] button → BLUETOOTH

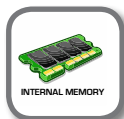

S9 is equipped with Bluetooth® Audio function.

Thanks to this technology, you'll be able to stream music wirelessly from a Bluetooth® capable smartphone, tablet or computer to S9.

See "Wireless Function" (p. 57).

MIDI

[MENU] button → MIDI

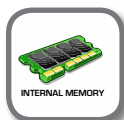

This group allow you to configure the MIDI parameters. You can transfer MIDI data between the S9 and your sequencer software or other MIDI device.



Here is a brief explanation of S9 keyboard parts:

| Part | Explanation |
|---------------|--|
| Main | If an orchestral or organ (tonewheel) sound is selected, the note played in the keyboard are sent to the MIDI Main part. Main Part |
| Coupled | This part can be combined with the Main part. To do this press the [COUPLED] button. The second part (COUPLED Part) play over the entire keyboard in combination with the Main part. Main Part + Coupled Part |
| Lower | This part is activated pressing the [LOWER] button. The keyboard is automatically split into two halves: Left and Right. The region of the keyboard to the left of the split point becomes the Lower part, while the region of the keyboard to the right of the split point becomes the Main part. Lower Part Main Part |
| Pedal | This part is activated pressing the [PEDAL] button. The keyboard is automatically split into two halves. The region of the keyboard to the left of the split point becomes the Pedal part, while the region of the keyboard to the right of the split point becomes the Main part. Pedal Part Main Part <p>If the Lower part is active, the pedal part is monophonic and the leftmost note played on the keyboard is added. In all other cases the Lower part si polyphonic.</p> |
| Memory | This part is used to receive or send MIDI messages for the selection of the memories by an external instrument. |
| Organ control | This part is used to control the position of the draw-faders via MIDI. |

1. Select the group of parameters you need (Reception, Transmission, MIDI Set and Save MIDI Set)

▶ RECEPTION



You can configure the MIDI receive parameters of Main, Coupled, Lower and Pedal part. Additionally, you can manage the received MIDI messages for the memories and Organ control.

1. Select the part you want to edit (Main, Coupled, Lower and Pedal).



In the example above we selected the Main part.

| Main, Coupled, Lower, Pedal | | |
|-----------------------------|------------------------|---|
| Parameter | Setting | Explanation |
| Status | OFF, ON Default: On | Select "On" if you want the selected part to receive MIDI data. |

| Main, Coupled, Lower, Pedal | | |
|-----------------------------|--------------------------|--|
| Parameter | Setting | Explanation |
| Channel | 1 ~ 16 | Allows you to assign a MIDI receive channel to the selected part. |
| Shift | -48~0~+48 Default : 0 | This parameter allows you to transpose the received note messages before sending them to the S9's tone generator. The maximum possible transposition is four octaves up (48) and down (-48). Each step represents a semi-tone. |
| Modulation | OFF, ON Default: On | These filters allow you to specify whether (On) or note (Off) the messages in question should be received. |
| Volume | | |
| Panpot | | |
| Expression | | |
| Aftertouch | | |
| Reverb | | |
| Hold | | |
| Sostenuto | | |
| Soft | | |
| PG (Program Change) | | |
| PB (Pitch Bender) | | |

| Part | MIDI RX channel (default) |
|---------------|---------------------------|
| Main | 1 |
| Coupled | 2 |
| Lower | 3 |
| Pedal | 4 |
| Memory | 15 |
| Organ control | 14 |

2. If you selected the "Memory" part, the following page is showed:



| Memory | | |
|-----------|------------------------|--|
| Parameter | Setting | Explanation |
| Status | OFF, ON Default: On | Select "On" if you want to receive MIDI messages for the memories selection. |
| Channel | 1 ~ 16 default: 15 | Allows you to assign a MIDI receive channel to the "Memory" part. |

3. If you selected the "Organ Control" part, the following page is showed:



| Memory | | |
|-----------|------------------------|--|
| Parameter | Setting | Explanation |
| Status | OFF, ON Default: On | Select "On" if you want to receive draw-faders MIDI messages. For details regarding the MIDI messages received, see "Draw-faders MIDI Controls" (p. 76). |
| Channel | 1 ~ 16 default: 14 | Allows you to assign a MIDI receive channel to the "Organ control" part. |

► TRANSMISSION



You can configure the MIDI transmission parameters of Main, Coupled, Lower and Pedal part. Additionally, you can manage the transmitted MIDI messages for the memories and Organ control. By the "COMMON" section, you can decide whether to send or not the "Active Sensing" MIDI messages.

1. Select the part you want to edit (Main, Coupled, Lower and Pedal).



In the example above we selected the Main part.

| Main, Coupled, Lower | | |
|----------------------|--------------------------|--|
| Parameter | Setting | Explanation |
| Status | OFF, ON Default: On | Select "On" if you want the selected part to transmit MIDI data. |
| Channel | 1 ~ 16 Default: 1 | Allows you to assign a MIDI transmit channel to the selected part. |
| Shift | -48~0~+48 Default : 0 | This parameter allows you to transpose the note messages before they are transmitted to an external MIDI device. The maximum possible transposition is four octaves up (48) or down (-48). |
| Local | OFF, ON Default: On | You can disconnect the part from the internal sound source ("Off") – or re-establish that connection ("On"). |
| Modulation | OFF, ON Default: On | These filters allow you to specify whether (On) or note (Off) the messages in question should be transmitted. |
| Volume | | |
| Panpot | | |
| Expression | | |
| Aftertouch | | |
| Reverb | | |
| Hold | | |
| Sostenuto | | |
| Soft | | |
| PG (Program Change) | | |
| PB (Pitch Bender) | | |

2. If you selected the "Memory" part, the following page is showed:



| Memory | | |
|-----------|------------------------|--|
| Parameter | Setting | Explanation |
| Status | OFF, ON Default: On | Select "On" if you want to transmit MIDI messages when you recall a memory. See "Working with the Memories" (p. 47). |

| Memory | | |
|-----------|-----------------------|--|
| Parameter | Setting | Explanation |
| Channel | 1 ~ 16 default: 15 | Allows you to assign a MIDI transmit channel to the "Memory" part. |

3. If you selected the "Organ Control" part, the following page is showed:



| Memory | | |
|-----------|------------------------|---|
| Parameter | Setting | Explanation |
| Status | OFF, ON Default: On | Select "On" if you want transmit position MIDI messages of the draw-faders. For details regarding the MIDI messages transmitted, see "Draw-faders MIDI Controls" (p. 76). |
| Channel | 1 ~ 16 default: 14 | Allows you to assign a MIDI transmit channel to the "Organ control" part. |

4. If you selected the "Common" part, the following page is showed:



| Common | | |
|----------------------|------------------------|---|
| Parameter | Setting | Explanation |
| Active Sensing (FEH) | OFF, ON Default: On | This MIDI message is transmitted constantly at intervals of approximately 250 ms. This MIDI message is used to monitor the MIDI connection. If there was a disconnection, after a connection has been made, the connected device no longer receives the active sensing (FEH) message and reset all notes that have remained actives. Select "On" if you want to transmit the Active Sensing MIDI. |

MIDI SET

MIDI Sets are memories for MIDI settings. The S9 provides five MIDI Set memories.

The first MIDI Set, called "Dexibell", is read-only and allows you to restore the MIDI factory setting.

The second MIDI Set called "KeyboardZone", it is read-only and is a fast way to configure the MIDI channels using the zones. See "Master Keyboard Zone" (p. 54).

The third MIDI Set called "Pedalboard", it is read-only. It's a quick way to configure the MIDI channels using an external Pedalboard. The keyboard pedal part is set Local Off. In other words, the internal connection between the keyboard part and the tone generator is interrupted.

The other three memories (User 1, User 2, User 3) allow use to memorize and recall your MIDI configuration.



1. Use the [DATA ENTRY] knob or the [▲][▼] to select the MIDI Set and press the "RECALL" Function button to load it.
2. Press the "SAVE" Function button to jump in the SAVE MIDI SET page.

SAVE MIDI SET



1. Use the [DATA ENTRY] knob or the [▲][▼] to select the MIDI Set memory and press the "WRITE" Function button to save your configuration.

GLOBAL

[MENU] button → GLOBAL



This parameter is automatically saved in the S9 global memory area.



| Parameter | Setting | Explanation |
|--------------|--|--|
| Auto OFF | Off, 5 min, 10 min, 30 min, 2 hours, 4 hours Default: 2 hours | This parameter allows you to cause the S9 to switch itself off after the selected number of minutes has elapsed if you are not using it. Select "Off" if you prefer not to use this function. |
| Switch | Global, Memory Default: Memory | Global: Set this value if you want the switch assignments are saved in the global area. The switch assignment does not depend on the recalled memory. Memory: Set this value if you want the switch assignments are saved in the Memories. The switch assignment depends on the recalled memory. For the switch assignments, see "ASSIGN 1, 2 SWITCH" (p. 65). |
| Pedal | Global, Memory Default: Memory | Global: Set this value if you want the pedal assignments are saved in the global area. The pedal assignment does not depend on the recalled memory. Memory: Set this value if you want the pedal assignments are saved in the Memories. The pedal assignment depends on the recalled memory. For the pedal assignments, see p. 64. |
| Motor Slider | Off, On Default: On | On: Set this value if you want the draw faders motorised. Off: Set this value if you do not want the draw faders motorised. |

| Parameter | Setting | Explanation |
|-----------|-----------------------------------|---|
| Wheel | Global, Memory Default: Memory | <p>Global: Set this value if you want the Wheel 1 and the Wheel 2 assignments are saved in the global area. The Wheel assignment does not depend on the recalled memory.</p> <p>Memory: Set this value if you want the Wheel 1 and the Wheel 2 assignments are saved in the Memories. The Wheel assignment depends on the recalled memory.</p> <p>For the Wheel assignments, see p. 65.</p> |

SOUND LIBRARY

[MENU] button → SOUND LIBRARY

You can import sounds library in the internal memory of S9 and use them in your performances. For details see "Sound Library" (p. 37).

SOUND SETUP

[MENU] button → SOUND SETUP

This is a useful function that allows you to prepare a sound set for a performance. For details see "Sound Setup (Export/Import)" (p. 41).

At your convenience, you can also download sound sets from the <http://www.dexibell.com/> website.

FACTORY RESET

[MENU] button → FACTORY RESET

This function allows you to recall the S9's original factory settings. Please see "Restoring the Factory Settings (Factory Reset)" (p. 36).

FACTORY SOUND

[MENU] button → FACTORY SOUND

This function allows you to restore all sound libraries as they came out of the factory. Please see "Restore the Factory Sounds" (p. 36).

VERSION INFO

[MENU] button → VERSION INFO

This page shows you the version number of the S9's operating system.

Effects Types and Parameters List

1: Thru

The effects processor is bypassed.

2: EP Tremolo

This effect cyclically modulates (Speed) the amplitude (Intensity) to add tremolo to the sound. It's the electric piano typical effect.

| Parameter | Setting | Explanation |
|-----------|-----------------|---------------------------------------|
| Speed | 0.10 ~ 12.50 Hz | Sets the speed of the tremolo effect. |
| Intensity | 0 ~ 100 | Depth to which the effect is applied. |

3: Equalizer

This is a four-band stereo equalizer (low, mid x 2, high).

| Parameter | Setting | Explanation |
|-----------|----------------|--|
| Low Freq | 40 ~ 400 Hz | Selects the frequency of the low range. |
| Low Gain | -12 ~ 0 ~ +12 | Adjusts the gain of the low frequency. |
| High Freq | 400 Hz ~ 8 KHz | Selects the frequency of the high range. |
| High Gain | -12 ~ 0 ~ +12 | Adjusts the gain of the high frequency. |
| Mid1 Freq | 100Hz ~ 4 KHz | Selects the frequency of the Mid1 range. |
| Mid1 Gain | -12 ~ 0 ~ +12 | Adjusts the gain of the Mid1 frequency. |
| Mid1 Q | 0.5 ~ 12.0 | Move this parameter to adjust the width of the area around the Middle 1 frequency that will be affected by the Gain setting. Higher values of Mid1 Q set narrowest area. |
| Mid2 Freq | 100Hz ~ 4KHz | Selects the frequency of the Mid2 range. |
| Mid2 Gain | -12 ~ 0 ~ +12 | Adjusts the gain of the Mid2 frequency. |
| Mid2 Q | 0.5 ~ 12.0 | Move this parameter to adjust the width of the area around the Middle 2 frequency that will be affected by the Gain setting. Higher values of Mid2 Q set narrowest area. |

4: Vibrato

Vibrato is a musical effect consisting of a regular, pulsating change of pitch. It is used to add expression to instrumental music.

| Parameter | Setting | Explanation |
|-----------|-----------------|--|
| Rate | 0.10 ~ 12.50 Hz | Sets the speed of the vibrato effect. |
| Intensity | 0 ~ 100 | Allows you to set the vibrato intensity. |

5: Flanger

This effect gives a significant swell and movement of pitch to the sound. It produces a metallic resonance effect.

| Parameter | Setting | Explanation |
|-----------|-----------------|--|
| Rate | 0.10 ~ 12.50 Hz | Adjust the modulation speed. |
| Intensity | 0 ~ 100 | Allows you to set the flanger intensity. |

| Parameter | Setting | Explanation |
|-----------|-------------|--|
| Feedback | -96 ~ +96 % | Adjusts the proportion of the flanger sound that is fed back into the effect. Negative (-) settings will invert the phase. |
| Balance | 0 ~ 100 | Balance the Volume between the direct and the effect sound. |
| PreDelay | 0 ~ 100 ms | Adjusts the delay from the direct signal and the moment when the flanger starts working. |
| Phase | 0 ~ 180 deg | This sets the LFO phase difference between the left and right, in steps of 10 degrees It give more spatial of the sound. |

6: Chorus

This effect adds thickness and warmth to the sound by modulating the delay time of the input signal. You can add spread to the sound by offsetting the phase of the left and right LFOs from each other.

| Parameter | Setting | Explanation |
|-----------|-----------------|---|
| Rate | 0.10 ~ 12.50 Hz | Adjust the modulation speed. |
| Intensity | 0 ~ 100 | Allows you to set the chorus intensity. |
| Feedback | -96 ~ +96 % | Adjusts the proportion of the chorus sound that is fed back into the effect. Negative (-) settings will invert the phase. |
| Balance | 0 ~ 100 | Balance the Volume between the direct and the effect sound. |
| PreDelay | 0 ~ 100 ms | Adjusts the delay from the direct signal and the moment when the chorus starts working. |
| Phase | 0 ~ 180 deg | This sets the LFO phase difference between the left and right, in steps of 10 degrees. |

7: Phaser

This effect creates a swell by shifting the phase. It is very effective on electric piano sounds. You can add spread to the sound by offsetting the phase of the left and right LFOs from each other.

| Parameter | Setting | Explanation |
|-----------|-----------------|---|
| Rate | 0.10 ~ 12.50 Hz | Adjust the modulation speed. |
| Intensity | 0 ~ 100 | Allows you to set the phaser intensity. |
| Feedback | -96 ~ +96 % | Adjusts the proportion of the phaser sound that is fed back into the effect. Negative (-) settings will invert the phase. |
| Phase | 0 ~ 180 deg | This sets the LFO phase difference between the left and right, in steps of 10 degrees. |

8: Reverb

This effect adds reverberation to the sound, simulating an acoustic space as a room or a larger halls or stadiums.

| Parameter | Setting | Explanation |
|-----------|---------|---|
| Level | 0 ~ 127 | Set the quantity of Reverb effect |
| Damping | 0 ~ 127 | Adjusts the amount of damping of the room (Carpet, Wood, Brick, Concrete, Marble). Higher values increase the amount of high-frequency attenuation. |

| Parameter | Setting | Explanation |
|-----------|------------|--|
| Room Size | 0 ~ 127 | It determines the size of the simulated room. |
| Width | 0 ~ 127 | Adjusts the stereo width of the Reverb effect. Higher value increase the stereo width. |
| PreDelay | 0 ~ 100 ms | Adjusts the delay from the direct signal and the moment when the reverb starts working. This is used to simulate the distance between the original signal and the reflective surfaces. |

9: Delay

The delay effect is used to simulate echo (repetition).

| Parameter | Setting | Explanation |
|-----------|-------------|---|
| Delay L | 0 ~ 750 ms | Sets the delay time for the left channel. |
| Delay R | 0 ~ 750 ms | Sets the delay time for the right channel. |
| Feedback | -96 ~ +96 % | Adjusts the proportion of the delay sound that is fed back into the effect. Negative (-) settings will invert the phase. |
| Wet | 0 ~ 100 % | Adjust the quantity of the delayed ("wet") signal. |
| Dry | 0 ~ 100 % | Adjust the quantity of the unmodified ("dry") signal. |

10: Cross Delay

Cross Delay allows you to create advanced stereo delay. Each echo can be sent to the opposite channel from the source signal (echo of the left channel is heard on the right).

| Parameter | Setting | Explanation |
|-----------|-------------|---|
| Delay L | 0 ~ 750 ms | Sets the delay time for the left channel. |
| Delay R | 0 ~ 750 ms | Sets the delay time for the right channel. |
| Feedback | -96 ~ +96 % | Adjusts the proportion of the delay sound that is fed back into the effect. Negative (-) settings will invert the phase. |
| Wet | 0 ~ 100 % | Adjust the quantity of the delayed ("wet") signal. |
| Dry | 0 ~ 100 % | Adjust the quantity of the unmodified ("dry") signal. |

11: Triple Tap Delay

The Triple Tap Delay produces three delay sounds: center, left and right..

| Parameter | Setting | Explanation |
|-----------|-------------|---|
| Delay L | 0 ~ 750 ms | Sets the delay time for the left channel. |
| Delay R | 0 ~ 750 ms | Sets the delay time for the right channel. |
| Delay C | 0 ~ 750 ms | Sets the delay time for the center (L+R) channel. |
| Feedback | -96 ~ +96 % | Adjusts the proportion of the delay sound that is fed back into the effect. Negative (-) settings will invert the phase. |
| Level L | 0 ~ 100 | Adjust the volume of the left delay sound. |
| Level R | 0 ~ 100 | Adjust the volume of the right delay sound. |
| Level C | 0 ~ 100 | Adjust the volume of the center delay sound. |
| Wet | 0 ~ 100 % | Adjust the quantity of the delayed ("wet") signal. |
| Dry | 0 ~ 100 % | Adjust the quantity of the unmodified ("dry") signal. |

12: Rotary

The rotary is a typical effect generated by the rotation of the speakers, this rotation creates a Larsen effect. It gives spaciousness to the sound.

| Parameter | Setting | Explanation |
|--------------|------------------------|--|
| Speed | Slow, Fast | Switches the speaker rotation speed between slow and fast. |
| Brake | OFF, ON | This parameter allows you to manually control the wheel brake. Off is the default; the tone wheels will turn normally. Changing this to On will make the tone wheels gradually slow down and stop. |
| Vibrato Sw | OFF, ON | Disable and enable the vibrato effect. |
| Vibrato Type | V1, C1, V2, C2, V3, C3 | This selects one of the six classic Vibrato/Chorus presets. "V" stands for Vibrato, and "C" stands for Chorus. |

13: Tremolo

This effect cyclically modulates (Speed) the amplitude (Intensity) to add tremolo to the sound.

| Parameter | Setting | Explanation |
|-----------|-----------------|---------------------------------------|
| Speed | 0.10 ~ 12.50 Hz | Sets the speed of the tremolo effect. |
| Intensity | 0 ~ 100 | Depth to which the effect is applied. |

14: Tremolo Pan

This effect is similar to the Tremolo. It include an extra parameter that indicate the phase between the left or right channel.

| Parameter | Setting | Explanation |
|-----------|-----------------|--|
| Speed | 0.10 ~ 12.50 Hz | Sets the speed of the tremolo effect. |
| Intensity | 0 ~ 100 | Depth to which the effect is applied. |
| Phase | 0 ~ 180 deg | This sets the LFO phase difference between the left and right, in steps of 10 degrees. |

15: Overdrive

This effect is designed to work and sound like an old tube amp turned up loud. It suitable for hard rock and similar musical genres.

| Parameter | Setting | Explanation |
|-----------|-------------------|---|
| Drive | 1 ~ 100 | Higher Drive settings, mean more distortion. |
| Tone | 100 Hz ~ 10.0 KHz | Use this parameter to accent or attenuate certain dominant or unwanted overtones. |
| Level | 0 ~ 100 | Increase or decrease the volume of the effect. |
| Low Freq | 80 ~ 400 | Selects the frequency of the low range. |
| Low Gain | -12 ~ 0 ~ +12 | Adjusts the gain of the low frequency. |
| High Freq | 800Hz ~ 8KHz | Selects the frequency of the high range. |
| High Gain | -12 ~ 0 ~ +12 | Adjusts the gain of the high frequency. |

16: Wah-Wah

It is a type of effect that alters the tone and frequencies of the input signal to create a unique sound, mimicking the human voice and taking the onomatopoeic name "Wah-Wah".

| Parameter | Setting | Explanation |
|----------------------|--------------------------------------|--|
| Mode | Auto, Manual, Envelope | <p>Auto: The "Manual" parameter is automatically controlled by the internal LFO.</p> <p>Manual: The "Manual" parameter is controlled by the expression pedal or the WHELL 2. Remember that in addition, the Expression Pedal socket must be assigned to the function "FX-MANUAL". See "EXPRESSION PEDAL" (p. 64) and "WHELL 2" (p. 65). This parameter can be also controlled by the aftertouch.</p> <p>Envelope: the effect is controlled by the envelope of the sound and consequently by the dynamics of the notes played on the keyboard.</p> |
| Manual | 0 ~ 127 | <p>Adjusts the center frequency at which the effect is applied.</p> <p>This parameter can be also controlled by the expression pedal or the WHELL 2 (if your instrument is equipped with WHELL 2). Remember that in addition, the Expression Pedal socket must be assigned to the function "FX-MANUAL". See "EXPRESSION PEDAL" (p. 40).</p> |
| Filter | Low Pass, High Pass, Band Pass, Peak | <p>Low Pass : The wah effect will be applied over a low frequency range.</p> <p>High Pass: The wah effect will be applied over a high frequency range.</p> <p>Band Pass : The wah effect will be applied over a narrow frequency range.</p> <p>Peak: The wah effect will be applied over a specific center frequency.</p> |
| Low Freq | 100Hz ~ 10.0KHz | Selects the frequency of the low range. |
| High Freq | 100Hz ~ 10.0KHz | Selects the frequency of the High range. |
| Low Q | 0.5 ~ 10.0 | Move this parameter to adjusts the width of the area around the Low or High Frequency. |
| Hi Q | 0.5 ~ 10.0 | |
| LFO Rate | 0.1Hz ~ 12.50Hz | Frequency of modulation. |
| LFO Curve | Linear, Quadratic | LFO curve trend. |
| Balance | 0 %~ 100% | Adjusts the balance between original and the effect sound. |
| Env Threshold | -40dB ~ 0dB | Adjust the threshold of the envelop |
| Env Attack | 0ms ~ 250ms | Adjust the attack of the envelop |
| Env Release | 0ms ~ 1000ms | Adjust the release of the envelop |

| Parameter | Setting | Explanation |
|------------------|--------------------------------------|---|
| Slope | 12db/Octave, 24db/Octave | The slope of filter attenuation is usually quantified in decibels per octave. |
| Type | Low Pass, High Pass, Band Pass, Peak | <p>Low Pass : Attenuates the frequencies above a cutoff frequency, allowing low frequencies to pass through the filter.</p> <p>High Pass: Attenuates the frequencies below a cutoff frequency, allowing high frequencies to pass through the filter.</p> <p>Band Pass : The filter is applied over a narrow frequency range.</p> <p>Peak: The filter is applied over a specific center frequency.</p> |
| Low Freq | 100Hz ~ 10.0KHz | Selects the frequency of the low range. |
| High Freq | 100Hz ~ 10.0KHz | Selects the frequency of the High range. |
| Low Q | 0.5 ~ 10.0 | Move this parameter to adjusts the width of the area around the Low or High Frequency. |
| Hi Q | 0.5 ~ 10.0 | |

18: Compressor

This filter that attenuates ("cut") some frequency range.

| Parameter | Setting | Explanation |
|---------------------|---------------|--|
| Threshold | -40dB ~ 0dB | The compression is activated only when the input signal exceeds the threshold level. Input levels above the threshold will be compressed, and input levels below the threshold will not be compressed. |
| Ratio | 1:1 ~ inf:1 | <p>This parameter determines how strong is the compression.</p> <ul style="list-style-type: none"> At 1:1, the compressor has no effect. For all other values the output signal will be compressed in according to the ratio value. At Inf:1, the compressor becomes a brick-wall limiter; once the signal hits the Threshold, the output level will no longer increase, regardless of the input level. |
| Knee Width | 0.0 ~ 1.0 | Increasing this value will produce a more soft volume change around the Threshold level. |
| Attack Time | 0ms ~ 250ms | This parameter determines how quickly the compressor will take affect after the signal crosses above the threshold. |
| Release Time | 0ms ~ 1000ms | This parameter controls how quickly the compressor will stop reducing volume level after the signal falls below the threshold. |
| Makeup | -24dB ~ -24dB | Allows you to boost the compressed signal. as compression often attenuates the signal significantly. |
| Stereo Link | Off, On | Set the parameter "On" to operate in stereo mode. |

17: Cut Filter

This filter that attenuates ("cut") some frequency range.

| Parameter | Setting | Explanation |
|---------------|---------|--|
| Manual | 0 ~ 127 | <p>Adjusts the center frequency at which the effect is applied.</p> <p>This parameter can be also controlled by the expression pedal or the WHELL 2. Remember that in addition, the Expression Pedal socket must be assigned to the function "FX-MANUAL". See "EXPRESSION PEDAL" (p. 40). This parameter can be also controlled by the aftertouch.</p> |

S9 Orchestral Tones List

MEMO

The bold tone number indicates that it can be used for the Chord Enhancer function.

| Num. | Name | PC | CC00 |
|-------------------|----------------|----|------|
| PIANO | | | |
| 0001 | VIVO Live | 2 | 2 |
| 0002 | Japan Grand | 2 | 5 |
| 0003 | Japan Live | 2 | 6 |
| 0004 | VIVO Upright | 1 | 2 |
| 0005 | VIVO Grand | 2 | 0 |
| 0006 | Pop Grand | 2 | 1 |
| 0007 | Japan Bright | 2 | 8 |
| 0008 | Classic Grand | 1 | 0 |
| 0009 | Japan Classic | 2 | 7 |
| 0010 | Bright Piano | 2 | 3 |
| 0011 | Piano Memory | 2 | 4 |
| 0012 | Japan Memory | 2 | 9 |
| 0013 | Elec.Grand | 3 | 2 |
| 0014 | E.Grand Trem | 3 | 3 |
| 0015 | Rock Piano | 3 | 1 |
| E.PIANO | | | |
| 0016 | Dyno Stage | 5 | 0 |
| 0017 | Dyno Trem | 5 | 7 |
| 0018 | Dyno Bell | 5 | 8 |
| 0019 | Suitcase | 5 | 1 |
| 0020 | Phaser EP | 5 | 2 |
| 0021 | Wurly | 5 | 5 |
| 0022 | Trem.Wurly | 5 | 6 |
| 0023 | Soft E.Piano | 5 | 3 |
| 0024 | Bright E.Piano | 5 | 4 |
| 0025 | FM Full Tines | 6 | 0 |
| 0026 | FM E.Piano | 6 | 1 |
| PERCUSSIVE | | | |
| 0027 | Doctor Clav | 8 | 2 |
| 0028 | Cool Clav | 8 | 0 |
| 0029 | Funky Clav | 8 | 3 |
| 0030 | Groovy Clav | 8 | 1 |
| 0031 | Wah-Wah Clav | 8 | 4 |

| Num. | Name | PC | CC00 |
|--------------------|----------------|-----|------|
| 0032 | Drive Clav | 8 | 5 |
| 0033 | Vibraphone | 12 | 0 |
| 0034 | Marimba | 13 | 0 |
| 0035 | Celesta | 9 | 0 |
| STRINGS | | | |
| 0036 | Easy Strings | 50 | 10 |
| 0037 | FastOrchestra | 50 | 4 |
| 0038 | Attack Strings | 49 | 2 |
| 0039 | Choir Strings | 52 | 1 |
| 0040 | Large Strings | 50 | 5 |
| 0041 | MellowStrings | 50 | 6 |
| 0042 | Soft Strings | 50 | 7 |
| 0043 | 5th Strings | 50 | 8 |
| 0044 | Slow Analog | 50 | 9 |
| PAD/CHOIR | | | |
| 0045 | Warm Pad | 90 | 0 |
| 0046 | Soft Pad | 90 | 1 |
| 0047 | Square Pad | 90 | 2 |
| 0048 | Organ Pad | 90 | 3 |
| 0049 | 90's Pad | 51 | 2 |
| 0050 | Mmh Choir | 53 | 0 |
| 0051 | Choir Pad | 54 | 1 |
| 0052 | Space Vox | 55 | 1 |
| 0053 | Fanta Bell | 101 | 0 |
| BRASS/SYNTH | | | |
| 0054 | Brass Sect. | 62 | 0 |
| 0055 | Brass Ens. | 62 | 1 |
| 0056 | Synth Brass | 63 | 0 |
| 0057 | Poly Brass | 63 | 1 |
| 0058 | Analog Brass | 63 | 2 |
| 0059 | Fat Syn Brass | 63 | 3 |
| 0060 | OB Synth 1 | 81 | 0 |
| 0061 | OB Synth 2 | 81 | 1 |
| 0062 | OB Synth 3 | 81 | 2 |
| 0063 | OB Synth 4 | 81 | 3 |
| 0064 | Lyle Lead | 81 | 4 |
| 0065 | Super Saw | 91 | 1 |
| 0066 | Fast Synth | 91 | 2 |
| 0067 | Poly Saw | 91 | 3 |

| Num. | Name | PC | CC00 |
|--------------------|----------------|-----|------|
| 0068 | Euro Synth | 91 | 4 |
| 0069 | Euro Stack | 94 | 0 |
| 0070 | Poly Chord | 94 | 1 |
| 0071 | Dexi Heaven | 101 | 1 |
| GUITAR/BASS | | | |
| 0072 | Nylon Guitar | 25 | 0 |
| 0073 | Steel Guitar | 26 | 0 |
| 0074 | Overdrive GT. | 30 | 0 |
| 0075 | Acoustic Bs. | 33 | 0 |
| 0076 | Double Bass | 33 | 3 |
| 0077 | Ac.Bass&Ride | 33 | 1 |
| 0078 | Double Bs&Ride | 33 | 4 |
| 0079 | Fingered Bs. | 34 | 0 |
| 0080 | 5 String Bass | 34 | 1 |
| 0081 | Picked Bs. | 35 | 0 |
| 0082 | Pedal Bass | 39 | 5 |
| 0083 | Pedal DoubleBs | 33 | 5 |
| 0084 | Modular Bass | 39 | 1 |
| 0085 | Fat Bass | 39 | 2 |
| 0086 | Reso Bass | 39 | 3 |
| 0087 | Big Reso Bass | 39 | 4 |
| 0088 | FM Bass | 40 | 3 |
| 0089 | Synth Bass | 39 | 0 |

Draw-faders MIDI Controls

| CC number | Value | Description | Part | Draw-faders |
|-----------|---------|---|-------|------------------|
| CC 16 | 0 ~ 127 | 0 = 0 1 = 1 2 = 2 3 = 3 4 = 4 5 = 5 6 = 6 7 = 7 8 = 8 | Main | Drawbars 16' |
| CC 17 | | | Main | Drawbars 5 1/3' |
| CC 18 | | | Main | Drawbars 8' |
| CC 19 | | | Main | Drawbars 4' |
| CC 20 | | | Main | Drawbars 2 2/3' |
| CC 21 | | | Main | Drawbars 2' |
| CC 22 | | | Main | Drawbars 1' 3/5' |
| CC 23 | | | Main | Drawbars 1 1/3' |
| CC 24 | | | Main | Drawbars 1' |
| CC 70 | | | Lower | Drawbars 16' |
| CC 71 | | | Lower | Drawbars 5 1/3' |
| CC 72 | | | Lower | Drawbars 8' |
| CC 73 | | | Lower | Drawbars 4' |
| CC 74 | | | Lower | Drawbars 2 2/3' |
| CC 75 | | | Lower | Drawbars 2' |
| CC 76 | | | Lower | Drawbars 1' 3/5' |
| CC 77 | | | Lower | Drawbars 1 1/3' |
| CC 78 | | | Lower | Drawbars 1' |
| CC 14 | | | Pedal | Drawbars 16' |
| CC 15 | | | Pedal | Drawbars 5 1/3' |
| CC 25 | | | Pedal | Drawbars 8' |
| CC 26 | | | Pedal | Drawbars 4' |
| CC 27 | | | Pedal | Drawbars 2 2/3' |
| CC 28 | | | Pedal | Drawbars 2' |
| CC 29 | | | Pedal | Drawbars 1' 3/5' |
| CC 30 | | | Pedal | Drawbars 1 1/3' |
| CC 31 | | | Pedal | Drawbars 1' |

| CC number | Value | Description | Percussion |
|-----------|-----------------|----------------------|-------------|
| CC 87 | 0 ~ 63~ 64 ~127 | 0 = Off, 1 = On | On/Off |
| CC 88 | | 0 = Normal, 1 = Soft | Normal/Soft |
| CC 89 | | 0 = Slow, 1 = Fast | Slow/Fast |
| CC 95 | | 0 = 2nd, 1 = 3rd | 2nd/3rd |

| CC number | Value | Description | Vibrato |
|-----------|-----------------|--|--------------|
| CC 84 | 1,2,3,4,5,6 | 1 = V1, 2 = C1, 3 = V2, 4 = C2, 5 = V3, 6 = C3 | Vibrato mode |
| CC 69 | 0 ~ 63~ 64 ~127 | 0 = Off, 1 = On | ON/OFF panel |

| CC number | Value | Description | Rotary Leslie |
|-------------------------|-----------------|--------------------|---------------|
| CC 80 (general purpose) | 0 ~ 63~ 64 ~127 | 0 = Off, 1 = On | On/Off |
| CC 82 (general purpose) | | 0 = Slow, 1 = Fast | Slow/Fast |
| CC 81 (general purpose) | | 0 = Off, 1 = On | Brake On/Off |

| CC number | Value | Description | Overdrive |
|-----------|-----------------|-----------------|-----------|
| CC 83 | 0 ~ 63~ 64 ~127 | 0 = Off, 1 = On | On/Off |
| CC 92 | 1 ~ 100 | | Drive |
| CC 94 | | | Tone |
| CC 90 | | | Level |

24 Troubleshooting

| Symptom | Action | Page |
|---|---|--------|
| Power turns automatically off. | This is normal and due to the Auto Power Off function. If necessary, set the parameter of the Auto Power Off function. If you don't need the power to turn off automatically, turn the "AUTO OFF" setting "Disable". | 70 |
| The instrument does not turn on. | Is the AC adaptor/power cord correctly connected to an AC outlet and to the S9? NOTE Do not use any AC adaptor or power cord other than the ones included. Doing so will cause malfunctions. | 17 |
| | Could you have turned the power on again immediately after turning the power off? Allow an interval of at least five seconds before turning the power on again. | - |
| No sound from the S9. | Did you switch the S9 on? | 20 |
| | Could the [VOLUME] knob be turned down? Select a higher setting. | - |
| | Did you selected a sound (organ or orchestral)? | 28, 24 |
| The volume level of the instrument is too low when it is connected to an amplifier. | Are you using a connection cable that contains a resistor? Use a connection cable that doesn't contain a resistor. | - |
| Insufficient volume from a device connected to the S9's INPUT jack. | Could you be using a connection cable that contains a built-in resistor? Use a connection cable that does not contain a resistor. | - |
| | Could the AUDIO IN Level be down? Select a higher setting. | 68 |
| Insufficient volume from or to a device connected to the S9's USB port. | Could the USB AUDIO Input Level be down? Select a higher setting. | 68 |
| | Could the USB AUDIO Output Level be down? Select a higher setting. | 68 |
| The pitch of the instrument is incorrect. | Is the "Tuning" or "Temperament" setting appropriate? Check the parameters. | 66 |
| | Did you transpose the instrument? | 34 |
| A "buzz" is heard from the external amplifier. | Is the external amplifier or other device used with the S9 connected to a different AC power outlet? Connect the amplifier or other device to the same AC outlet as the S9. | - |
| | The noise may be due to interference caused by the use of a mobile phone in close proximity to the instrument. Turn off the mobile phone, or use it further away from the instrument. | - |
| | | - |
| Unable to read from/write to USB Memory. | Check the format of your USB Memory. The S9 can use USB Memory that has been formatted as FAT. If your USB Memory was formatted using any other method, please re-format it as MS-DOS FAT. | - |
| Can't save to USB Memory. | Could the USB Memory be write protected? | - |
| | Is there sufficient free space on the USB Memory? | - |
| Audio recording won't start or stops unexpectedly. | Is there sufficient free space on the USB Memory? | - |
| The songs won't play. | The file type of the song is not one of the file types that the S9 can play. | 53 |
| | It may be that the song data is damaged. | - |
| This "dexi-organ-xx" model name does not appear in the Bluetooth device list of your mobile device. | Have you made the instrument visible to other devices? | 57 |
| The music data played back by the mobile device cannot be heard through the S9. | Was the pairing function initiated between this unit and the mobile device? | 56 |
| The motorised draw-faders do not move automatically. | Is the "Motor Slider" parameter is set to ON? Please set the parameter to ON. | 70 |

25 Specifications

| ITEMS | | S9 |
|---------------------------------|---|---|
| KEYBOARD TYPE | TP 400 Hybrid (with wood parts) | |
| TONE GENERATOR | T2L: Sampling and Modelling Technology | |
| MODELLING | Reactive to player articulation (Orchestral sounds) | |
| SAMPLING | XXL wave size, holophonic recording up to 15 seconds on lower piano notes | |
| SOUND WAVE FORMAT | 24 bit linear - 48 KHz (Internal processing and DSP at 32 bit floating) | |
| DIGITAL ANALOG CONVERSION (DAC) | 24 bit linear - 48 KHz, Dynamic Range, S/N:106dB | |
| MAXIMUM POLYPHONY | Unlimited with 320 Oscillator | |
| ORGAN TYPES | TW1, TW2, FARF, VX, PIPE + User1, User2 downloadable from website | |
| SOUNDS | Over 100 Organ Preset + 85 Sounds + User downloadable from website (Compatible with .sf2) | |
| TONE WHEEL | 9 motorised | |
| MEMORY | Internal: 81 User: Unlimited loadable from USB Memory | |
| KEYBOARD MODE | 4 Parts (MAIN, LOWER, COUPLED, PEDAL) | |
| TOUCH SENSITIVITY | 7 Types + Fixed | |
| REVERB | 24 Types | |
| EFFECTS | Rotary, Overdrive, Vibrato/Chorus for Organ + 2 FX x 14 types for each part | |
| MASTER EQUALIZER | 3-band Digital Equalizer | |
| MASTER TUNING | 7 hystorical presets + fine adjustable | |
| CHORD ENHANCER | Yes | |
| CONTROLLERS | Draw-faders (Organ TW, S1~S9 Reverber and Volume) | |
| | FX Encoder x 6 | |
| | Data Entry/Song Level Encoder x 1 | |
| | Master Volume Knob | |
| PLAYER AUDIO | .wav, .aiff, .mp3, in all format, frequency and bit rate | |
| RECORDER AUDIO | .wav (48 kHz, 32-bit floating) on USB Memory | |
| MASTER TUNING | YES: 415,4Hz to 466,1 Hz (adjustable increments of 0,1 Hz) + 2 Preset (440 Hz, 442 Hz) | |
| TEMPERAMENT | 9 Types + 3 User | |
| WIRELESS CONNECTION | • Bluetooth® audio streaming | |
| RHYTHM PATTERNS | X MURE APP for i-Phone and i-Pad (FREE) with multitracks audio patterns | |
| CONNECTORS | DC IN socket | for supplied AC adaptor |
| | AUDIO IN jack | Stereo miniature phone type |
| | Unbalanced Output (L/Mono, R) jacks | 1/4-inch phone type x 2 |
| | Balanced Output (L, R) | XLR type x 2 |
| | Phones jacks | 1 x Stereo miniature phone type 1 x Stereo 1/4-inch phone type |
| | USB COMPUTER (Type B port) | Digital Audio OUT on USB (24 bit, 48 KHz) Digital Audio IN on USB (24 bit, 48 KHz) |
| | USB MEMORY (Type A port) | To Host (MIDI), To Device (MEMORY) |
| | MIDI sockets | IN, OUT, THRU |
| | DAMPER Pedal (HOLD) socket | Progressive Damper Action Pedal with sympatetic resonance simulation (Accept on/off pedal also) |
| | ASSIGN 1 Pedal [FOOT] socket | Assignable |
| | ASSIGN 2 Pedal [EXPRESSION] socket | Assignable |
| | ASSIGN 3 Pedal [MORPHING] socket | Assignable |
| POWER SUPPLY | 24V DC 2.5A , supplied AC/DC adaptor | |
| POWER CONSUMPTION | Stand By: < 0,2 W Maximum: 20 W "ErP" LEVEL VI for Echo efficiency on stand-by consumption | |
| DIMENSIONS | 1270 (W) x 354 (D) x 130 (H) 50 (W) x 13-15/16 (D) x 5-1/8 (H) inches | |
| WEIGHT | 20 kg (excluding AC adaptor) 44 lbs 2 oz (excluding AC adaptor) | |
| SUPPLIED ACCESSORIES | Quick Guide AC adaptor (DEXIBELL DYS602-240250-18208A) Damper Pedal (DEXIBELL DX CP1) Music Rest | |
| OPTIONS (sold separately) | DX HF7 Professional Headphones | |

• Bluetooth® is registered trademarks of Bluetooth SIG, Inc.

26 Index

Symbols

A

| | |
|----------------------|----|
| AC Adaptor | 17 |
| Adding a Library | 38 |
| Audio Backing Tracks | 56 |
| AUDIO INPUT | 68 |
| AUTO OFF | 21 |

B

| | |
|------------|----|
| Bluetooth® | 57 |
|------------|----|

C

| | |
|------------------|----|
| Computer | 18 |
| CONTROLS | 63 |
| COUPLED FX | 63 |
| COUPLED SETTING | 63 |
| Cursor | 22 |
| Cursor Operation | 22 |

D

| | |
|------------------------|----|
| DC IN jack | 17 |
| Demo | 21 |
| Digital Player devices | |
| Connecting | 18 |
| Display | 22 |
| Draw-faders | 29 |

E

| | |
|-----------------------------------|----|
| Effect | |
| Reverb Effect | 32 |
| Export | |
| Exporting the Internal Memory Set | 49 |
| Exporting a Sound Set | 41 |

F

| | |
|--------------------------------|----|
| Factory Sounds | 36 |
| File name | |
| Assigning the Name You Specify | 23 |

G

| | |
|--------|----|
| GLOBAL | 70 |
|--------|----|

H

| | |
|---------------------|----|
| Harmonic Percussion | 31 |
| Headphones | 18 |

I

| | |
|-----------------------|----|
| Import | |
| Importing Memory Set | 50 |
| Importing a Sound Set | 41 |

J

K

| | |
|----------------|----|
| KEYBOARD TOUCH | 63 |
|----------------|----|

L

| | |
|---------------|----|
| LOWER FX | 63 |
| LOWER SETTING | 63 |

M

| | |
|--|-------|
| MASTER EQ | 63 |
| MASTER TUNE | 66 |
| Memories | |
| Exporting the Internal Memory Set in the USB Memory | 49 |
| Importing Memory Set from the USB Memory into Internal Memory. | 50 |
| Recalling your settings from an USB Memory | 49 |
| Recalling your settings from Internal Memory | 47 |
| Renaming a Memory | 49 |
| MEMORY | 67 |
| MIDI | 19,68 |
| MIDI zones | 54 |
| Morphing | 29 |
| Music Rest | 20 |

N

O

| | |
|---------------|----|
| Organ Section | 28 |
| Organ Types | 28 |
| Overdrive | 30 |

P

| | |
|--------------------------|----|
| Pairing | 57 |
| Parameters | |
| GLOBAL | 70 |
| PEDAL FX | 63 |
| PEDAL Part | 25 |
| Pedals | 17 |
| Player Devices | 18 |
| Power On/Off | 20 |
| Turning the Power On/Off | 20 |
| Presettled Organ | 28 |

Q

| | |
|-------------|----|
| Quick Guide | 14 |
|-------------|----|

R

| | |
|----------------------------|----|
| Record | |
| Recording Your Performance | 53 |
| Rename | |
| Renaming a Memory | 49 |
| Reverb | |
| Reverb Effect | 32 |
| REVERB | 63 |

S

| | |
|--------------------------|----|
| SETTING | |
| SETTING Parameters Group | 62 |

Song

| | |
|----------------|----|
| Playing a Song | 51 |
|----------------|----|

| | |
|---------------|----|
| Sound Library | 37 |
|---------------|----|

| | |
|-------------------------------|----|
| Sounds | |
| Personalizing Your Sounds T2L | 42 |

| | |
|-------------|----|
| Sound Setup | 41 |
|-------------|----|

| | |
|----------------|----|
| Specifications | 78 |
|----------------|----|

| | |
|--|----|
| Split | |
| Splitting the Keyboard Range and Playing Two Different Tones | 25 |

| | |
|------------|----|
| SPLIT MODE | 63 |
|------------|----|

T

| | |
|------------|----|
| T2L EDITOR | 63 |
|------------|----|

| | |
|---------------|----|
| T2L-Modelling | 42 |
|---------------|----|

| | |
|-------------|----|
| TEMPERAMENT | 66 |
|-------------|----|

| | |
|-----------|-------|
| tonewheel | 28,40 |
|-----------|-------|

| | |
|----------|----|
| TRANPOSE | 63 |
|----------|----|

| | |
|-----------------|----|
| Troubleshooting | 77 |
|-----------------|----|

| | |
|-------------|----|
| TUNE | |
| MASTER TUNE | 66 |

| | |
|--------|----|
| TUNING | 66 |
|--------|----|

| | |
|-----------|----|
| TW ASSIGN | 29 |
|-----------|----|

U

| | |
|--|----|
| USB Memory | |
| Connecting an USB Memory | 19 |
| Exporting the Internal Memory Set in the USB Memory | 49 |
| Importing Memory Set from the USB Memory into Internal Memory. | 50 |
| Recalling your settings from an USB Memory | 49 |

V

W

| | |
|------------------------------|----|
| Wireless | |
| Already Paired Mobile Device | 58 |
| Pairing a Mobile Device | 57 |

X

| | |
|--------|----|
| X MURE | 56 |
|--------|----|

Y

Z

| | |
|-------------|----|
| Zone (MIDI) | 54 |
|-------------|----|



For European Countries

This product complies with the requirements of EMC Directive 2004/108/EC.

For Canada

NOTICE

This Class B digital apparatus meets all requirements of the Canadian Interference-Causing Equipment Regulations.

AVIS

Cet appareil numérique de la classe B respecte toutes les exigences du Règlement sur le matériel brouilleur du Canada.

For European Countries

EUROPEAN COMMUNITY DECLARATION OF CONFORMITY Radio and Telecommunications Terminal Equipment.

Dexibell declares that the wireless module of this unit is in compliance with the essential requirements and other relevant provisions of Directive 1999/5/EC.

IMPORTANT NOTICE FOR THE UNITED KINGDOM

IMPORTANT: THE WIRES IN THIS MAINS LEAD ARE COLOURED IN ACCORDANCE WITH THE FOLLOWING CODE.

BLUE: NEUTRAL
BROWN: LIVE

As the colours of the wires in the mains lead of this apparatus may not correspond with the coloured markings identifying the terminals in your plug, proceed as follows:

The wire which is coloured BLUE must be connected to the terminal which is marked with the letter N or coloured BLACK.

The wire which is coloured BROWN must be connected to the terminal which is marked with the letter L or coloured RED.

Under no circumstances must either of the above wires be connected to the earth terminal of a three pin plug.

DEXIBELL

DEXIBELL
is a brand of

PROEL SPA
(Worldwide Headquarters)
Via alla Ruenia, 37/43
64027 Sant'Omero (TE) - ITALY
Tel. +39 0861 81241
Fax +39 0861 887865
P.I. 00778590679
N.Reg.AEE IT 08020000002762

info@dexibell.com
www.dexibell.com